



1974 - 2024









DESIGN CATALOGUE



DYSTRYBTOR PARASOLI OGRODOWYCH SCOLARO

www.scolaro-parasole.pl
e-mail: kontakt@scolaro-parasole.pl
tel. +48 605 194 418









STANDARD

 	Vela Titanium	13
 STD	Lido Dark	21
 STD	Lido Starwhite	25
 STD	Lido Titanium	29
 STD PRO	Napoli Standard	37
 STD PRO	Rimini Standard	45
 STD PRO	Palladio Standard	53

RETRATTILI / RETRACTABLES

PRO 	Galileo Dark	127
PRO 	Galileo Starwhite	131
PRO 	Galileo Wood	135
PRO 	Galileo Maxi Dark	143
PRO 	Galileo Maxi Starwhite	147



BRACCIO /SIDE POST

 	Napoli Braccio	79
 	Rimini Braccio	87
 	Torino Braccio	95
PRO 	Leonardo Braccio	103
PRO 	Pompei Braccio	111
PRO 	Palladio Braccio	119

TELESCOPIC

PRO 	Leonardo Telescopic	63
PRO 	Palladio Telescopic	71
PRO   BIG	Capri Dark	155
PRO   BIG	Capri Starwhite	159

GRANDI COPERTURE / SPECIAL STRUCTURES

PRO  BIG	Alu Poker / Double Dark	167
PRO  BIG	Alu Poker / Double Starwhite	171
PRO  BIG	Wook Poker / Double	175

TAVOLO E PANCHE / TABLES AND BENCHES

Romeo	183
Giulietta	185
Basi / Bases	186
Optional cross metal	191
Carter	192
Ballast	194
Ground Fixing	195
Stability	196
Materiali e Finiture/ Materials and Finishing	202
Accessories	203
Fabric Collection	204
Kit Led Pro / Capri	207

PRO PROFESSIONAL HEAVY DUTY

Ombrelloni progettati per uso professionale. Robusti e adatti per uso intenso.
Developed for a commercial employ. Strong and heavy duty Stark. Geeignet fuer einen intensiven, gewerblichen Einsatz.

HANDY+FUNCTIONAL

Ombrellone di qualità, ma sviluppato con concetti di praticità e funzionalità.
Quality parasol, developed with concepts of practicality and functionality
Qualitaetsschirm, praktisch und leicht einsetzbar.

DESIGN AND INNOVATION

Ombrellone dal design innovativo e non convenzionale per creare ambienti moderni ed esclusivi.
Parasol with an innovative and unconventional design to create modern and exclusive ambiances.
Sonnenschirm mit innovativem und unkonventionellem Design. Fuer moderne und exklusive Milieu.

STD STANDARD

Ombrelloni a palo centrale. Classici, ma sempre attuali e molto diffusi.
Central pole parasols. Classic, but always popular and widespread.
Mittelmastschirme. Klassisch, aber stets aktuell und stark verbreitet.

CANTILEVER

Ombrelloni a braccio laterale.
Cantilever parasols.
Pendelschirme.

BIG **BIG SHADE STRUCTURES**

Ombrelloni con strutture sviluppate per coprire grandi superfici.
Parasols developed to cover large surfaces.
Sonnenschirme fuer die Beschattung grosser Flaechen.

RETRACTABLE

Ombrellone retrattile. Sistema di apertura e chiusura dell'ombrellone anche in presenza di arredo.
Possibilità di inclinazione fino a 60°C.
Retractable parasol. Opening and closing without moving the furniture. Inclination up to 60°C.
Einziehbarer Schirm. Oeffnung und Schliessung oberhalb von Tischen und Stuehlen. Neigung bis zu 60°C.

TELESCOPIC

Ombrelloni a palo centrale con chiusura telescopica.
Central pole parasols with telescopic opening system.
Mittelmastschirme mit teleskopischem Oeffnungssystem.



INTRODUZIONE INTRODUCTION

IT

Scolaro è un'azienda nata 50 anni fa come antico laboratorio artigianale di ombrelloni DOC e trae le sue radici nelle vicinanze di Venezia, luogo intriso di storia e bellezza senza tempo, che ha ispirato generazioni di artisti.

L'ampia gamma di articoli è studiata per il Contract, l'arredo giardino e il settore pubblicitario ed è costituita da ombrelloni in legno e alluminio con palo centrale, palo laterale e con telaio telescopico. La politica aziendale costantemente rivolta alla soddisfazione del cliente finale consente ora a Scolaro di esportare i propri prodotti in più di 70 Paesi. All'esperienza e capacità manipolativa aggiunge negli anni sempre maggiori tecnologie per migliorare lo standard qualitativo e da semplice prodotto per riparare dal sole ne ha fatto un elegante strumento per l'arredamento personalizzato.

Il design, le nuove soluzioni tecniche e l'abbinamento dei materiali migliori, segnano l'evoluzione e l'utilizzo dell'ombrellone, il tutto garantito da un processo produttivo interamente italiano.

I nostri articoli sono progettati, sviluppati e prodotti interamente all'interno della nostra azienda con sede in Italia. Particolare cura per la rifinitura e il controllo di qualità sono parte integrante della nostra politica.

Grazie ai materiali impiegati e ai dispositivi tecnici i nostri articoli sono particolarmente robusti e adatti per un uso intenso e professionale. L'utilizzo di tessuti acrilici impermeabili, di legno, acciaio e alluminio trattati ne garantiscono una lunga vita. L'azienda Scolaro presta particolare attenzione alla facilità di manutenzione e alla disponibilità di componenti di ricambio garantita nel tempo.

EN

Scolaro is a company born 50 years ago as an ancient workshop of DOC umbrellas and draws its roots in the vicinity of Venice, a place steeped in history and timeless beauty, which has inspired generations of artists.

The wide range of items is designed for contract, garden furniture and advertising sector, consists of wooden and aluminum umbrellas with central and side pole and telescopic frame. The company policy constantly aimed at final customer satisfaction allows Scolaro to export its products to more than 70 countries. To the experience and manipulative skills are added over the years more and more technologies to improve the quality standard, making a simple product for sheltering from the sun an elegant tool for personalized furnishing.

Design, new technical solutions and the combination of the best materials mark the evolution and use of the sunshade, all guaranteed by an entirely Italian production process.

Our products are designed, developed and produced entirely in-house by our company based in Italy. Special care for finishing and quality control are an imperative part of our policy. Thanks to the materials used and the technical devices, our products are particularly robust and suitable for intensive and professional use. The application of waterproof acrylic fabrics, treated wood, steel and aluminum ensure their long life.

Scolaro Company pays special attention to ease of maintenance and the readiness of spare parts guaranteed over time.

41
PRODUCT
RANGES

1000+
VARIANTS

+70
COUNTRIES

>7000^{M2}
PRODUCTION
FACILITY

50 ANNI DI TRADIZIONE, INNOVAZIONE E CREATIVITÀ MADE IN ITALY: L'ARTE DELL'ECCELLENZA

50 YEARS OF TRADITION, INNOVATION AND CREATIVITY
MADE IN ITALY: THE ART OF EXCELLENCE

IT

Dal 1974 i nostri ombrelloni sono affidabili, in linea con le tendenze dell'outdoor e destinati a durare nel tempo, grazie alla sostenibilità dei migliori materiali utilizzati. Da generazioni, l'Italia è sinonimo di eccellenza artigianale, con un patrimonio culturale che abbraccia secoli di tradizione e maestria. Questa eredità si riflette nella nostra azienda, dove rispettiamo e preserviamo il meglio del passato, ma guardiamo costantemente al futuro. Vivere all'aria aperta è un'esigenza sana e sempre più sentita, in ogni luogo. Offrire comfort e sicurezza con ombrelloni dallo stile raffinato è il nostro lavoro da 50 anni.

Investiamo in tecnologie all'avanguardia per migliorare la qualità dei nostri prodotti e rendere il nostro processo di produzione, interamente 100% Made in Italy, sempre più efficiente.

La ricerca e lo sviluppo sono i pilastri su cui costruiamo il nostro futuro, consentendoci di offrire ai nostri clienti soluzioni all'avanguardia che soddisfano le esigenze del mondo moderno. Le competenze manifatturiere e il know-how, la passione per la bellezza e l'attenzione ai dettagli si uniscono per creare prodotti unici, che rappresentano il meglio dello stile Italiano.

Questo rende Scolaro un'azienda leader che si impone in mercati anche molto diversi tra loro, ma uguali nello scegliere la qualità migliore. I nostri primi cinquant'anni ci hanno dato la soddisfazione di una crescita continua.

La stabilità e la solidità economica si abbina alla forza di un brand di alto livello, sempre più conosciuto e riconoscibile, capace di distribuire i propri prodotti nelle location più prestigiose ed esclusive al mondo.



50

1974 - 2024

EN

Since 1974 our umbrellas are reliable, in line with the trends of the outdoor and intended to last over time, thanks to the sustainability of the quality of the materials used.

For generations, Italy has been synonymous of artisanal excellence, with a cultural heritage spanning centuries of tradition and craftsmanship. This legacy is reflected in our company, where we respect and preserve the best of the past, but constantly looking to the future. Living in the open air is a healthy and highly demanded, in every place. Offering comfort and safety with refined style umbrellas has been our job for 50 years.

We invest in cutting-edge technologies to improve the quality of our products and make our production process, 100% Made in Italy, increasingly efficient. Research and development are the pillars on which we build our future, enabling us to offer our customers state of the art solutions that meet the needs of the modern world. Manufacturing skills and know-how, passion for beauty and attention to detail come together to create unique products that represent the best of Italian style.

This makes Scolaro a leading company that stands out in markets that are also very different from each other but equivalent in choosing the best quality. Our first fifty years have given us the satisfaction of continuous growth.

The stability and economic solidity is combined with the strength of a high level brand, increasingly known and recognizable, able to distribute its products in the most prestigious and exclusive locations in the world.



EN

Our products are designed, developed and manufactured entirely inside our company based in Italy. Special care for finishing and quality control are an integral part of our policy. Thanks to the materials used and the technical equipment, our items are strong and suitable for heavy and professional employ. The use of waterproof acrylic fabrics, treated wood, steel and aluminium grant a long life. Particular attention for an easy maintenance and the availability of spare parts is guaranteed over time.



IT

I nostri articoli sono progettati, sviluppati e prodotti interamente all'interno della nostra azienda con sede in Italia. Particolare cura per la rifinitura e il controllo di qualità sono parte integrante della nostra politica. Grazie ai materiali impiegati e ai dispositivi tecnici i nostri articoli sono particolarmente robusti e adatti per un uso intenso e professionale. L'utilizzo di tessuti acrilici impermeabili, di legno, acciaio e alluminio trattati ne garantiscono una lunga vita. La ditta Scolaro presta particolare attenzione alla facilità di manutenzione e alla disponibilità di componenti di ricambio garantita nel tempo.

POLITICA AMBIENTALE ENVIRONMENTAL POLICY

Consideriamo fondamentale che le nostre attività siano svolte nel rispetto dell'ambiente, riducendo il più possibile i propri impatti e le fonti di inquinamento, gestendo in modo ottimale le risorse e promuovendo la riduzione e il corretto smaltimento dei rifiuti.

La nostra politica ambientale si ispira ai seguenti principi:

- La riduzione dell'impatto ambientale e il miglioramento delle prestazioni ambientali e degli standard di sicurezza negli ambienti di lavoro rientrano tra i criteri che concorrono alla definizione delle strategie aziendali.
- La consapevolezza di ciascuno (proprietà, dipendenti, collaboratori, fornitori) in merito alle implicazioni ambientali e di sicurezza delle proprie attività costituiscono elemento indispensabile per il miglioramento delle prestazioni di tutta l'azienda.

We consider it fundamental that our activities are carried out with respect for the environment, reducing as much as possible their impacts and sources of pollution, optimally managing resources and promoting the reduction and proper disposal of waste.

Our environmental policy is inspired by the following principles:

- Reducing environmental impact and improving environmental performance and safety standards in the workplace are among the criteria that contribute to the definition of corporate strategies.
- The awareness of each (property, employees, collaborators, suppliers) regarding the environmental and safety implications of their activities are indispensable elements for improving the performance of the entire company.

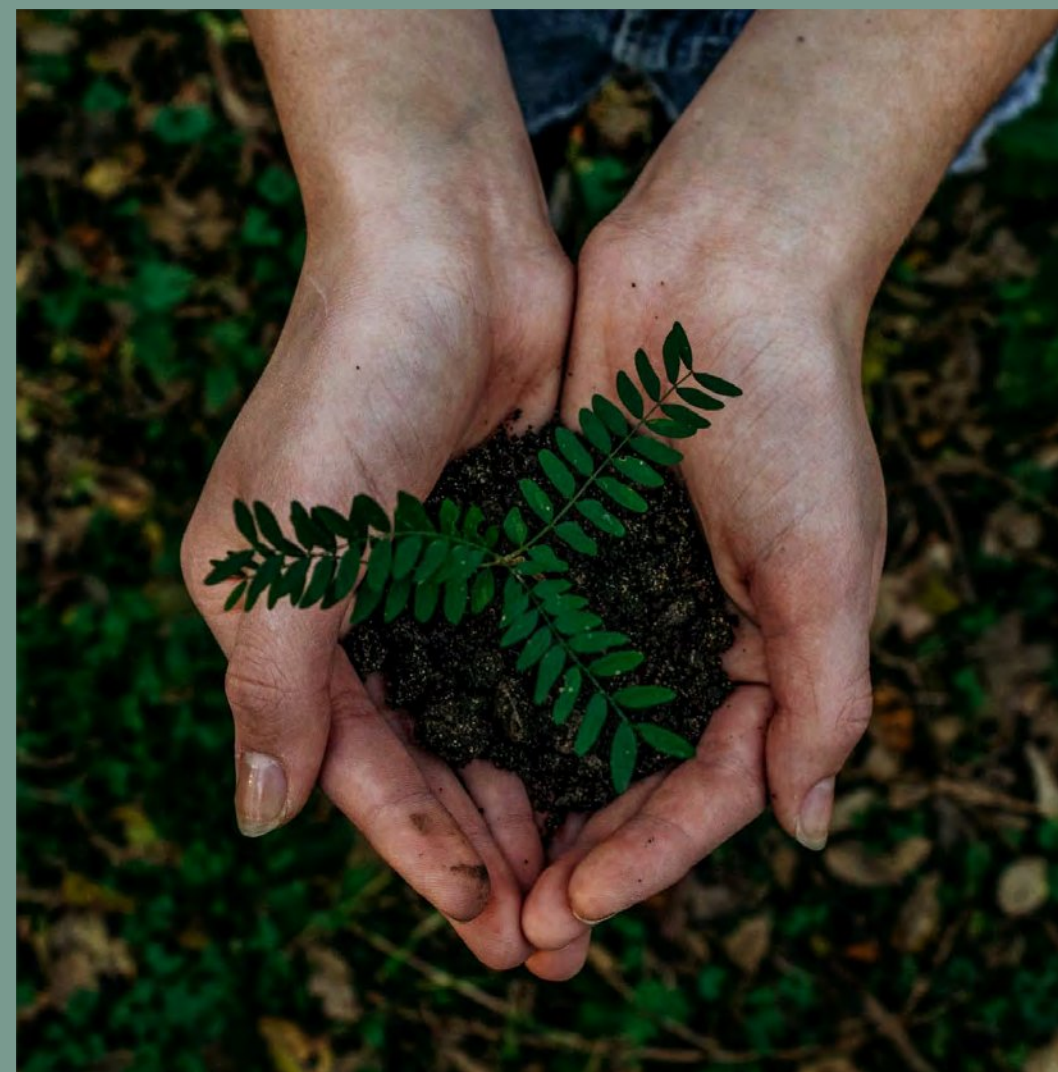



VELA TITANIUM **NEW**

L'ombrellone Vela ridefinisce il concetto e l'architettura dell'ombra, inedito e fuori dagli schemi. Il design della copertura si evolve lasciandosi ispirare dal mare e sagomare dal vento, ottenendo linee sinuose ed ergonomiche. Dalla fusione armonica tra un ombrellone e una vela nasce una sinergia tra resistenza dei materiali e leggerezza delle forme. Un oggetto unico per valorizzare il Vostro ambiente esterno.

EN



The parasol Vela redefines the concept and architecture of the shadow, unusual and unconventional. The cover design evolves taking inspiration from the sea and is shaped by the wind, resulting in sinuous and ergonomic lines. From the harmonic fusion between a parasol and a sail, a synergy between material strength and lightness of form, takes shape. A unique item to enhance your outdoor environment.



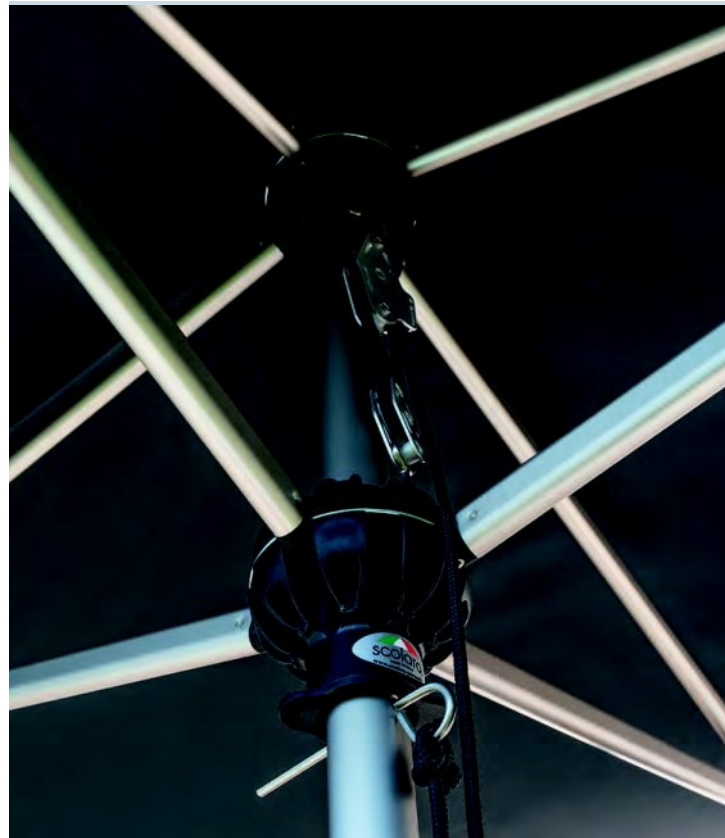

14



-  -
-  200x200 | 300x300
-  -

DE

Der Sonnenschirm Vela definiert den Begriff und die Architektur des Schattens, ungewöhnlich und unkonventionell. Das Design der Bespannung lässt sich vom Meer inspirieren und durch den Wind modeln. Ergebnis sind ergonomische und gewundene Linien. Die Kombination aus Schirm und Segel ergibt eine Synergie zwischen Kraft und Leichtigkeit. Ein einzigartiger Schirm der die Aussenausstattung aufwertet.

FR

Le parasol Vela redéfinit le concept et l'architecture de l'ombre, insolite et non conventionnelle. La conception de la couverture évolue en s'inspirant de la mer et façonné par le vent, ce qui entraîne des lignes sinuées et ergonomique. De la fusion harmonieuse entre un parasol et une voile né une synergie entre la résistance des matériaux et la légèreté de la forme. Un article unique pour améliorer votre environnement extérieur.

ES

El Parasol Vela redefine el concepto y la arquitectura de la sombra, nuevo y poco convencional. El diseño del tejido evoluciona inspirándose en el mar y las formas que toma el viento, consiguiendo líneas sinuosas y ergonómicas. De la unión armónica entre un parasol y una vela, nace una sinergia entre la resistencia de los materiales y la ligereza de las formas, un objeto único para mejorar su ambiente al aire libre.

NL

De parasol Vela geeft het begrip schaduw anders weer, ongewoon en onconventioneel. De vormgever van het doek liet zich inspireren door de zee en de wind. Het resultaat is ergonomisch met strakke lijnen. Door de harmonieuze samenvoeging van een parasol en een zeil ontstaat een synergie tussen stabiliteit van materialen en luchtigheid van de vormgeving. Een unieke parasol, die een grote bijdrage levert aan de uitstraling van ieder terras.

15



IT
 Telaio in alluminio con finitura effetto titanium.
 Viteria in acciaio inox e componenti in nylon colore nero.

EN
 Aluminum frame with titanium effect finish.
 Stainless steel hardware and black-colored nylon components.

DE
 Alugestell mit Pulverbeschichtung Farbe Titanium.
 Edelstahlschrauben und Nylonzubehoer in schwarz.

FR
 Structure en aluminium avec effet titane.
 Vis en acier inoxydable et composants en nylon noir.

ES
 Estructura de aluminio con acabado titanio.
 Tornillos de acero inoxidable y componentes de nailon negro.

NL
 Aluminium frame met titanium-look. Roestvrijstalen onderdelen en zwarte nylon delen.



CHARACTERISTICS



2,0 x 2,0
C2020 VSP

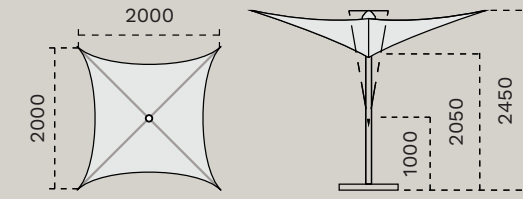

11 0,10 40 4 18x30

3,0 x 3,0
C3030 VSP

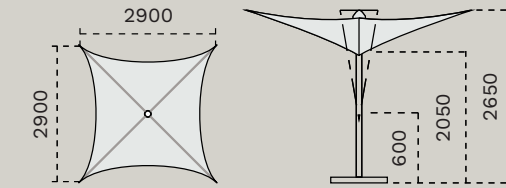

14 0,10 50 4 18x35

OPTIONAL

BASES p. 186

GROUND FIXING p. 195



2,0 x 2,0
C2020 VSP



BF6565D

BC35MA4
BC55MA4

BC151GRA4

BTC
+BTT45

CP3030ZS
+BTT45

3,0 x 3,0
C3030 VSP



BF6565D
BF6666D

BC55MA4
BC80MA4

BC151GRA4

BTC
+BTT55

CP3030ZS
+BTT55

FINISHING



• Stecca con sistema "easy change"
Ribs with "easy change" system



• Doppia Carrucola
Double pulley



• Alu Titanium



• Alu Titanium

COLOUR RANGE - p.204

ACRILYC 350GR

Senza volant / without volant



A1N

T6N

T9N

ALL OPTIONS

VERIFICA LA STABILITÀ - p.196

Check stability - Vérifiez la stabilité - Stabilität prüfen - Compruebe la estabilidad - Controleer de stabiliteit



LIDO DARK NEW

Ombrellone elegante e funzionale con sistema “push-up” che permette l’apertura con una semplice spinta, senza la necessità di fare sforzi e fare leva su una manovella o utilizzare una corda e carrucola: questo ne rende l’utilizzo pratico ed intuitivo. Progettato per essere estremamente funzionale, elegante e facile da utilizzare. Struttura leggera ma robusta realizzata in materiali di alta qualità che contribuiscono a una sensazione di modernità e sofisticatezza. Adatto ad un utilizzo nel settore balneare, piscine, balconi e terrazze.

EN

Elegant and functional umbrella with “push-up” system that allows it to be opened with a simple push, without the need to use a crank or a rope: this makes its use practical and intuitive. Designed to be extremely functional, stylish and easy to use. Lightweight but with a sturdy structure made of high-quality materials that contribute to a modern and sophisticated feel. Suitable for use in seaside area, swimming pools, balconies and terraces.





DE

Eleganter und funktioneller Schirm mit „Push-up“-System, das das Öffnen mit einem einfachen Druck ermöglicht, ohne dass eine Kurbel oder ein Seil erforderlich sind. Dies macht die Verwendung praktisch und intuitiv. Konzipiert um äußerst funktional, trendy und einfach zu bedienen zu sein. Leichtes und dennoch starkes Gestell aus hochwertigen Materialien, modern und anspruchsvoll. Geeignet für Küstengebiete, Schwimmbäder, Balkone und Terrassen.

FR



Parasol élégant et fonctionnel avec système “push-up” qui permet de l’ouvrir d’une simple pression, sans avoir besoin de tourner une manivelle ou d’utiliser une corde ou une poulie: cela rend son utilisation pratique et intuitive. Conçu pour être extrêmement fonctionnel, élégant et facile à utiliser. Construction légère mais robuste faite de matériaux de haute qualité qui contribuent à une sensation de modernité et de sophistication. Convient pour une utilisation dans le secteur balnéaire, les piscines, les balcons et les terrasses.

ES

Parasol elegante y funcional con sistema “push-up” que permite abrir con un simple empujón, sin necesidad de girar un mango ni utilizar cuerda o polea: esto hace que su uso sea práctico e intuitivo. Diseñado para ser extremadamente funcional, elegante y fácil de usar. Construcción ligera pero resistente, fabricada con materiales de alta calidad que contribuyen a una sensación de modernidad y sofisticación. Apto para uso en el sector costero, piscinas, balcones y terrazas.

NL

Een elegante en functionele parasol met een ‘push-up’-systeem waardoor hij met een simpele druk kan worden geopend, zonder dat je een hendel hoeft te draaien of een touw en katrol hoeft te gebruiken: dit maakt hem praktisch en intuïtief in gebruik. Ontworpen om uiterst functioneel, elegant en gebruiksvriendelijk te zijn. Lichtgewicht maar wel robuuste constructie van hoogwaardige materialen die bijdragen aan een moderne en verfijnde uitstraling. Geschikt voor gebruik aan de kust, bij zwembaden, op balkons en terrassen.

-  250
-  200x200
-  -



LIDO STARWHITE NEW

Ombrellone elegante e funzionale con sistema “push-up” che permette l’apertura con una semplice spinta, senza la necessità di fare sforzi e fare leva su una manovella o utilizzare una corda e carrucola: questo ne rende l’utilizzo pratico ed intuitivo. Progettato per essere estremamente funzionale, elegante e facile da utilizzare. Struttura leggera ma robusta realizzata in materiali di alta qualità che contribuiscono a una sensazione di modernità e sofisticatezza. Adatto ad un utilizzo nel settore balneare, piscine, balconi e terrazze.

EN

Elegant and functional umbrella with “push-up” system that allows it to be opened with a simple push, without the need to use a crank or a rope: this makes its use practical and intuitive. Designed to be extremely functional, stylish and easy to use. Lightweight but with a sturdy structure made of high-quality materials that contribute to a modern and sophisticated feel. Suitable for use in seaside area, swimming pools, balconies and terraces.





DE

Eleganter und funktioneller Schirm mit „Push-up“-System, das das Öffnen mit einem einfachen Druck ermöglicht, ohne dass eine Kurbel oder ein Seil erforderlich sind. Dies macht die Verwendung praktisch und intuitiv. Konzipiert um äußerst funktional, trendy und einfach zu bedienen zu sein. Leichtes und dennoch starkes Gestell aus hochwertigen Materialien, modern und anspruchsvoll. Geeignet für Küstengebiete, Schwimmbäder, Balkone und Terrassen.

FR



Parasol élégant et fonctionnel avec système “push-up” qui permet de l’ouvrir d’une simple pression, sans avoir besoin de tourner une manivelle ou d’utiliser une corde ou une poulie: cela rend son utilisation pratique et intuitive. Conçu pour être extrêmement fonctionnel, élégant et facile à utiliser. Construction légère mais robuste faite de matériaux de haute qualité qui contribuent à une sensation de modernité et de sophistication. Convient pour une utilisation dans le secteur balnéaire, les piscines, les balcons et les terrasses.

ES

Parasol elegante y funcional con sistema “push-up” que permite abrigo con un simple empujón, sin necesidad de girar un mango ni utilizar cuerda o polea: esto hace que su uso sea práctico e intuitivo. Diseñado para ser extremadamente funcional, elegante y fácil de usar. Construcción ligera pero resistente, fabricada con materiales de alta calidad que contribuyen a una sensación de modernidad y sofisticación. Apto para uso en el sector costero, piscinas, balcones y terrazas.

NL

Een elegante en functionele parasol met een ‘push-up’-systeem waardoor hij met een simpele druk kan worden geopend, zonder dat je een hendel hoeft te draaien of een touw en katrol hoeft te gebruiken: dit maakt hem praktisch en intuïtief in gebruik. Ontworpen om uiterst functioneel, elegant en gebruiksvriendelijk te zijn. Lichtgewicht maar wel robuuste constructie van hoogwaardige materialen die bijdragen aan een moderne en verfijnde uitstraling. Geschikt voor gebruik aan de kust, bij zwembaden, op balkons en terrassen.

-  250
-  200x200
-  -



LIDO TITANIUM **NEW**

Ombrellone elegante e funzionale con sistema “push-up” che permette l’apertura con una semplice spinta, senza la necessità di fare sforzi e fare leva su una manovella o utilizzare una corda e carrucola: questo ne rende l’utilizzo pratico ed intuitivo. Progettato per essere estremamente funzionale, elegante e facile da utilizzare. Struttura leggera ma robusta realizzata in materiali di alta qualità che contribuiscono a una sensazione di modernità e sofisticatezza. Adatto ad un utilizzo nel settore balneare, piscine, balconi e terrazze.

EN

Elegant and functional umbrella with “push-up” system that allows it to be opened with a simple push, without the need to use a crank or a rope: this makes its use practical and intuitive. Designed to be extremely functional, stylish and easy to use. Lightweight but with a sturdy structure made of high-quality materials that contribute to a modern and sophisticated feel. Suitable for use in seaside area, swimming pools, balconies and terraces.





DE

Eleganter und funktioneller Schirm mit „Push-up“-System, das das Öffnen mit einem einfachen Druck ermöglicht, ohne dass eine Kurbel oder ein Seil erforderlich sind. Dies macht die Verwendung praktisch und intuitiv. Konzipiert um äußerst funktional, trendy und einfach zu bedienen zu sein. Leichtes und dennoch starkes Gestell aus hochwertigen Materialien, modern und anspruchsvoll. Geeignet für Küstengebiete, Schwimmbäder, Balkone und Terrassen.

FR

Parasol élégant et fonctionnel avec système “push-up” qui permet de l’ouvrir d’une simple pression, sans avoir besoin de tourner une manivelle ou d’utiliser une corde ou une poulie: cela rend son utilisation pratique et intuitive. Conçu pour être extrêmement fonctionnel, élégant et facile à utiliser. Construction légère mais robuste faite de matériaux de haute qualité qui contribuent à une sensation de modernité et de sophistication. Convient pour une utilisation dans le secteur balnéaire, les piscines, les balcons et les terrasses.

ES

Parasol elegante y funcional con sistema “push-up” que permite abrir con un simple empujón, sin necesidad de girar un mango ni utilizar cuerda o polea: esto hace que su uso sea práctico e intuitivo. Diseñado para ser extremadamente funcional, elegante y fácil de usar. Construcción ligera pero resistente, fabricada con materiales de alta calidad que contribuyen a una sensación de modernidad y sofisticación. Apto para uso en el sector costero, piscinas, balcones y terrazas.

NL

Een elegante en functionele parasol met een ‘push-up’-systeem waardoor hij met een simpele druk kan worden geopend, zonder dat je een hendel hoeft te draaien of een touw en katrol hoeft te gebruiken: dit maakt hem praktisch en intuïtief in gebruik. Ontworpen om uiterst functioneel, elegant en gebruiksvriendelijk te zijn. Lichtgewicht maar wel robuuste constructie van hoogwaardige materialen die bijdragen aan een moderne en verfijnde uitstraling. Geschikt voor gebruik aan de kust, bij zwembaden, op balkons en terrassen.

250

200x200

-

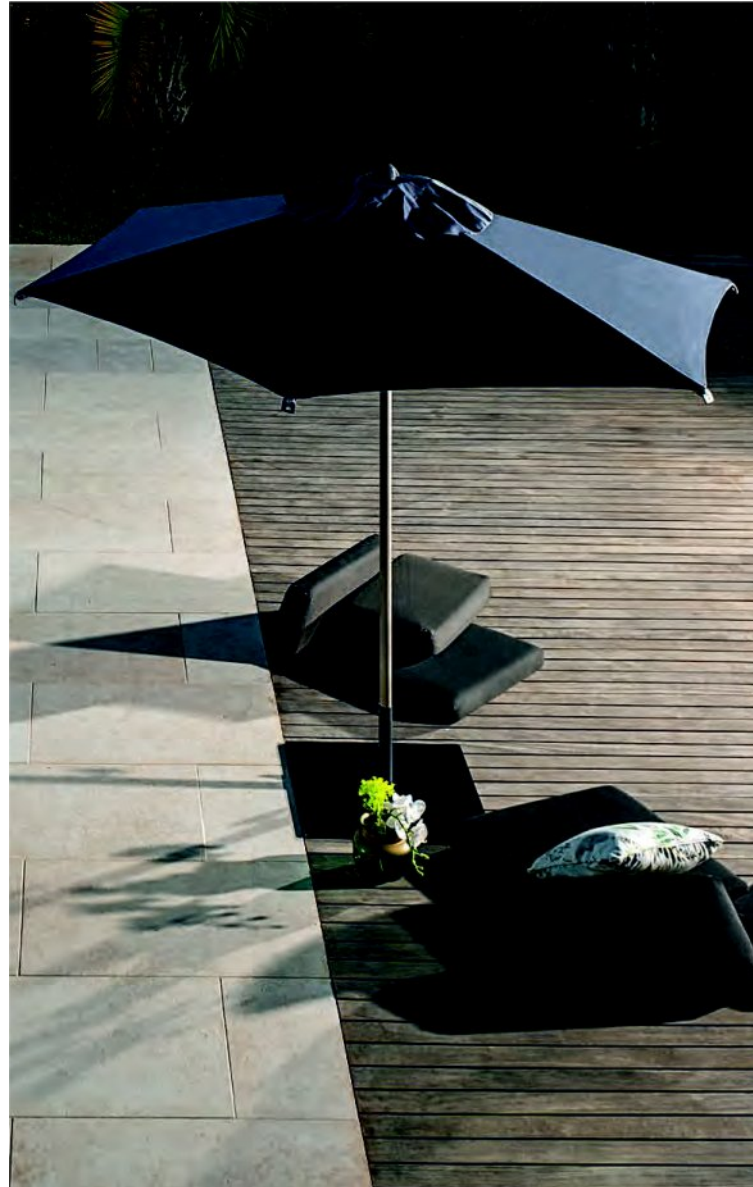
*IT*

Telaio in alluminio con verniciatura a polveri colore grigio antracite, bianco opaco o anodizzato titanium. Viteria in acciaio inox e componenti in nylon. Sistema di corone in plastica completamente rinnovato, con design e funzionalità che rendono questo prodotto esclusivo.

EN

Aluminum frame with powder coating anthracite grey and matt white or anodized Titanium finish. Stainless steel hardware and nylon components. Completely renovated plastic crown system with new design and increased functionality that make this product unique.

DE

Aluminiumgestell pulverbeschichtet Farbe Anthrazitgrau, Mattweiss oder mit Titanium-Effekt. Edelstahlzubehoer und Nylonbestandteile. Komplett erneuertes Kunststoffkronensystem. Einzigartiges und funktionelles Design.

FR

Structure en aluminium vernie à poudre couleur gris anthracite, Starwhite et finition effet Titane. Vis en acier inoxydable et composants en nylon. Système de couronne en plastique entièrement renouvelé, avec un design et une fonctionnalité qui rendent ce produit exclusif.

ES

Estructura de aluminio con recubrimiento en polvo gris antracita, Starwhite et acabado efecto titanio. Tornillos de acero inoxidable y componentes de nailon. Sistema de corona plástica completamente renovado, con diseño y funcionalidad que hacen exclusivo este producto.

NL

Aluminium frame met poedercoating lak kleur antracietgrijze, Starwhite of titanium-look. Roestvrijstalen en nylon onderdelen. Volledig vernieuwd kunststof kroonsysteem, met design en functionaliteit die dit een exclusief product maken.





CHARACTERISTICS



2,0 x 2,0	C2020LDD		7	0,09	40	4	18x30
	C2020LDW						
	C2020LDT						
2,5	C2500LDD		8	0,09	40	6	18x30
	C2500LDW						
	C2500LDT						

OPTIONAL

BASES p. 186

GROUND FIXING p. 195



2,0 x 2,0	C2020LDD	◆	BF6565D	BC35MA4 BC55MA4	BC151GRA4	BTC +BTT45	CP3030ZS +BTT45
	C2020LDW		BF6565W				
	C2020LDT		BF6565D				
2,5	C2500LDD	◆	BF6565D	BC35MA4 BC55MA4	BC151GRA4	BTC +BTT45	CP3030ZS +BTT45
	C2500LDW		BF6565W				
	C2500LDT		BF6565D				

FINISHING

- Camino antivento
Wind cap
- Stecca con sistema "easy change"
Ribs with "easy change" system
- Apertura semplificata a spinta
Easy push opening system
- Alu Dark
• Alu Starwhite
• Alu Titanium
- Alu Dark
• Alu Starwhite
• Alu Titanium

COLOUR RANGE - p.204

ACRILYC 350GR

Senza volant / without volant



VERIFICA LA STABILITÀ - p.196

Check stability - Vérifiez la stabilité - Stabilität prüfen - Compruebe la estabilidad - Controleer de stabiliteit



NAPOLI STANDARD

Ombrellone robusto e pratico a palo centrale in alluminio verniciato a polveri epossidiche colore grigio antracite. Particolarmente apprezzato da molti anni per la robustezza e compatibilità con qualsiasi ambiente e utilizzo. Palo Diam. 50 mm.

EN

Strong and handy parasol with central pole epoxy coated color anthracite grey. Particularly appreciated for many years for its robustness and compatibility with any environment and use. Pole Diam. 50 mm.





DE

Starker und handlicher Sonnenschirm mit Mittelmast. Farbe Anthrazitgrau pulverbeschichtet. Seit vielen Jahren besonders geschätzt für seine Stabilität und vielfache Verwendungszwecke. Mastdurchmesser 50 mm.

FR

Parasol robuste et pratique avec mat central vernis couleur gris anthracite. Particulièrement apprécié depuis de nombreuses années pour sa robustesse et sa compatibilité avec tous les environnements et toutes les utilisations. Mat diam. 50 mm.

ES

Parasol robusto y práctico de palo central de aluminio pintado con polvo epoxi de color gris antracita. Particularmente apreciado desde hace años por la robustez y compatibilidad con cualquier ambiente y uso. Palo de 50 mm ø.

NL

Sterke en praktische parasol met middenmast. Gepoedercoat in antracietgrijs. Sinds jaar en dag is dit model populair dankzij de goede stabiliteit. Geschikt voor iedere omgeving, dus ook voor de horeca. Doorsnede mast 50 mm.

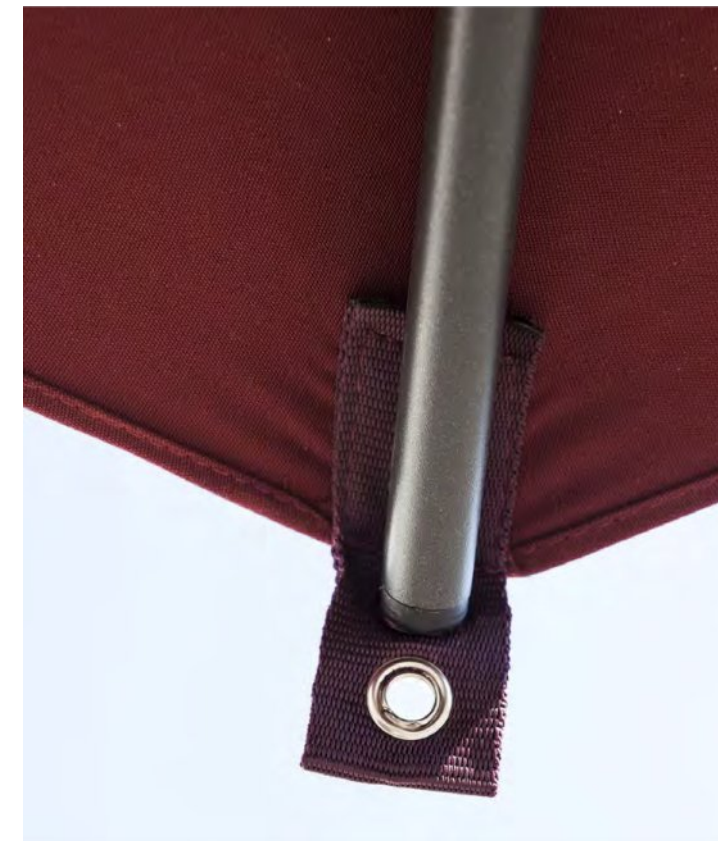

350



300x300



200x300 | 300x400



40

IT

Telaio in alluminio verniciato a polveri colore antracite. Viteria in acciaio inox e componenti in nylon colore nero.

EN

Frame: aluminium powder coated anthracite grey. Stainless steel screws and components in black nylon.

DE

Gestell: Pulverbeschichtetes Aluminium Farbe Anthrazitgrau. Edelstahlschrauben und Zubehoer aus Nylon. Farbe schwarz.

FR

Armature: Aluminium vernis couleur gris anthracite. Visserie en inox et composants en nylon noir.

ES

Polvo de aluminio recubierto marco de antracita. Accesorios de nylon. Tornillo de aciere inox y componentes de nylon negro.

NL

Mast en baleinen: aluminium, antracietgrijs geëpoxideerd. Schroeven van RVS, overige bewegende delen zijn van nylon.

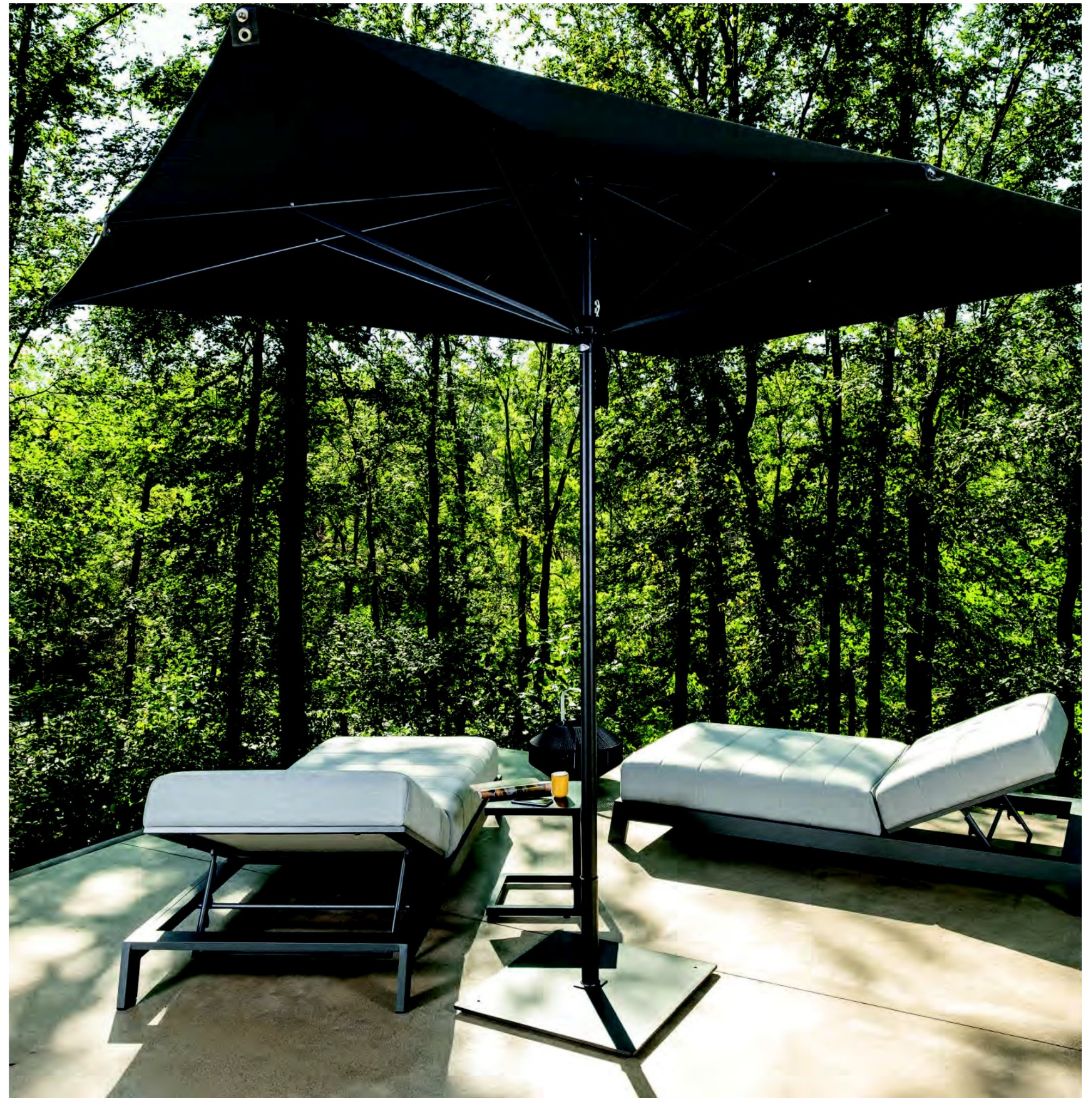

41

CHARACTERISTICS



3,5
C3500 NAS

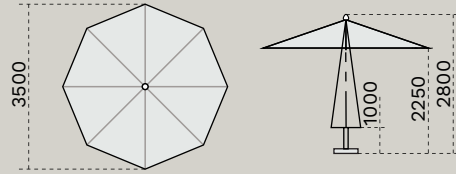

15 0,10 50 8 18x30

3,0 x 3,0
C3030 NAS

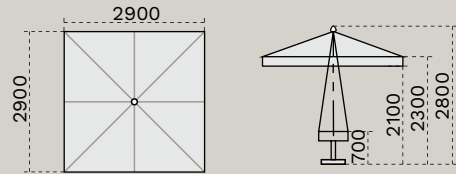

15 0,11 50 8 18x30

2,0 x 3,0
C2030 NAS

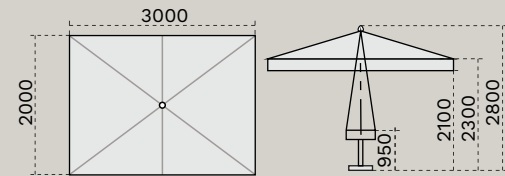

14 0,14 50 6 18x30

3,0 x 4,0
C3040 NAS

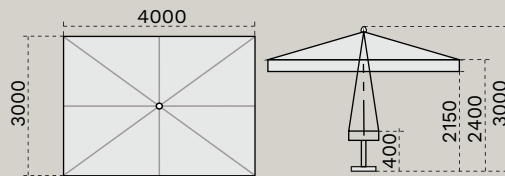

18 0,12 50 8 18x30

FINISHING



• Camino antivento
Wind cap



• Alu Dark



• Stecca con sistema "easy change"
Ribs with "easy change" system



• Alu Dark



• Doppia Carrucola
Double pulley

OPTIONAL

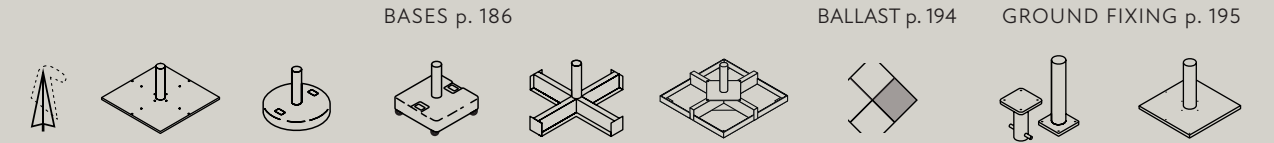

3,5
C3500 NAS



BF6565D
BF6666D

BC55MA4
BC80MA4

BC151GRA4

/

/

/

BTC
+BTT55

CP3030ZS
+BTT55

3,0 x 3,0
C3030 NAS



BF6565D
BF6666D

BC55MA4
BC80MA4

BC151GRA4

BQ8080DS

BUD8080DS



BTC
+BTT55

CP3030ZS
+BTT55

2,0 x 3,0
C2030 NAS



BF6565D
BF6666D

BC55MA4
BC80MA4

BC151GRA4

/

/

/

BTC
+BTT55

CP3030ZS
+BTT55

3,0 x 4,0
C3040 NAS



BF6565D
BF6666D

BC55MA4
BC80MA4

/

BQ8080DS

BUD8080DS



BTC
+BTT55

CP3030ZS
+BTT55

COLOUR RANGE - p.204

ACRILYC 350GR

Con volante / with volant



A1S

C3030 NAS

C2030 NAS

C3040 NAS

Senza volante / without volant



A1N

ALL OPTIONS



T2N

T3N

C3500 NAS



T2S

T3S

C3030 NAS

C3040 NAS



T6N

T7N

C3500 NAS

C3030 NAS

C3040 NAS



T8N

T9N

S1N



RIMINI STANDARD

Ombrellone robusto e pratico a palo centrale in alluminio verniciato a polveri epossidiche colore Starwhite. Compatibile con qualsiasi ambiente e utilizzo. Palo Diam. 50 mm.

EN

Strong and handy parasol with central pole in aluminum epoxy coated color Starwhite. Suitable for any environment and use. Pole Diam. 50 mm.





46



47

DE

Starker und handlicher Sonnenschirm mit Mittelmast, pulverbeschichtet Farbe Starwhite. Geeignet fuer alle Umgebungen und Verwendungszwecke. Mastdurchm. 50 mm.

FR



Parasol robuste et pratique avec mat central vernis couleur Starwhite. Compatibilité avec tous les environnements et toutes les utilisations. Mat diam. 50 mm.

ES

Parasol robusto y práctico con palo central de aluminio pintado con polvo epoxi de color Starwhite. Compatible con cualquier ambiente y uso. Palo de 50 mm ø.

NL

Sterke en handzame parasol met middenmast, gepoedercoat in de kleur Starwhite. Geschikt voor iedere omgeving en algemeen gebruik. Diameter mast 50 mm.

-  350
-  300x300
-  300x400

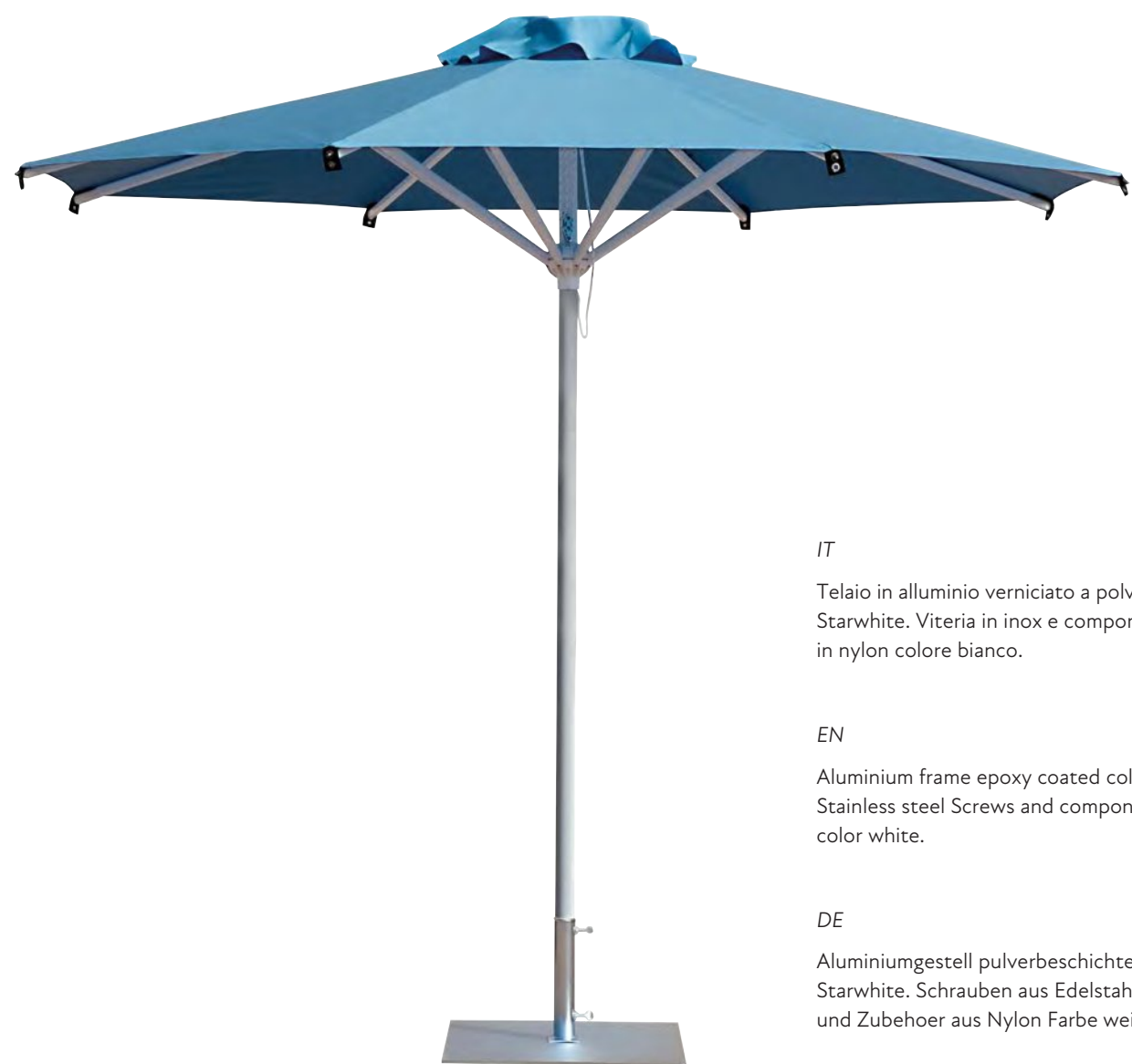

IT

Telaio in alluminio verniciato a polveri colore Starwhite. Viteria in inox e componenti in nylon colore bianco.

EN

Aluminium frame epoxy coated color Starwhite. Stainless steel Screws and components in nylon color white.

DE

Aluminiumgestell pulverbeschichtet Starwhite. Schrauben aus Edelstahl und Zubehoer aus Nylon Farbe weiss.

FR

Armature en aluminium vernis couleur Starwhite. Visserie en inox composants en nylon blanc.

ES

Estructura de aluminio pintado con polvo epoxi color Starwhite. Tornillería en Inox y componentes en Nylon color blanco.

NL

Gepoedercoat aluminium frame in de kleur Starwhite. Schroeven van RVS en onderdelen van nylon in de kleur wit.



CHARACTERISTICS



3,5
C3500 RIS

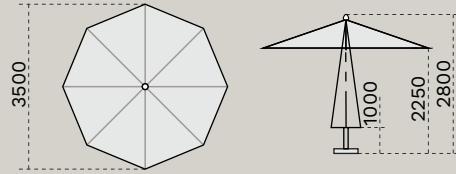

14 0,10 50 8 18x30

3,0 x 3,0
C3030 RIS

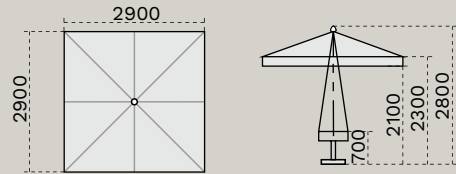

19 0,11 50 8 18x30

3,0 x 4,0
C3040 RIS

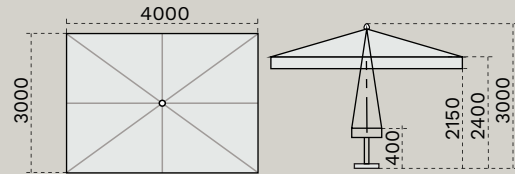

22 0,12 50 8 18x30

OPTIONAL

BASES p. 186

BALLAST p. 194

GROUND FIXING p. 195

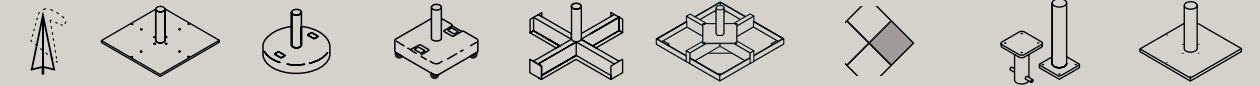

3,5
C3500 RIS

◆ BF6565W
BF6666W BC55MA4
BC80MA4 BC151GRA4 / / / BTC
+BTT55 CP3030ZS
+BTT55

3,0 x 3,0
C3030 RIS

◆ BF6565W
BF6666W BC55MA4
BC80MA4 BC151GRA4 BQ8080ZS BUD8080BS ◆ BTC
+BTT55 CP3030ZS
+BTT55

3,0 x 4,0
C3040 RIS

◆ BF6565W
BF6666W BC55MA4
BC80MA4 / BQ8080ZS BUD8080BS ◆ BTC
+BTT55 CP3030ZS
+BTT55

50 FINISHING



• Camino antivento
Wind cap



• Starwhite



• Stecca con sistema "easy change"
Ribs with "easy change" system



• Starwhite



• Doppia Carrucola
Double pulley

COLOUR RANGE - p.204

ACRILYC 350GR

Con volante / with volant



A1S

C3030 RIS

C3040 RIS

Senza volante / without volant



A1N

ALL OPTIONS



T2N



T3N

C3500 RIS



T2S



T3S

C3030 RIS

C3040 RIS



T6N



T7N

C3500 RIS

C3030 RIS

C3040 RIS



T8N



T9N



S1N

VERIFICA LA STABILITÀ - p.196

Check stability - Vérifiez la stabilité - Stabilität prüfen - Compruebe la estabilidad - Controleer de stabiliteit



PALLADIO STANDARD

Modello storico, presente nella gamma Scolaro da quasi 50 anni. La linea classica, ma allo stesso tempo semplice ed essenziale lo rendono adatto a tutti gli ambienti e inattaccabile da tendenze di moda. Prodotto più venduto e diffuso. Ampia gamma e varianti disponibili.

EN

Historical model, present in the Scolaro range for almost 50 years. Its classic shape but at the same time simple and essential, makes it suitable for all environments and uninfluenced to fashion trends. Best-selling product with wide range and variants available.





54



- 250 | 300 | 350 | 400
- 200x200 | 300x300 | 350x350 | 400x400
- 200x300 | 300x400

55

DE

Historisches Model. Handwerkskunst seit ueber 50 Jahren. Klassiker, der fuer alle Anwendungen geeignet ist, auch fuer den gewerblichen Einsatz. Von Modetrends unangreifbar. Bestseller Produkt mit umfangreicher Anzahl von Massen und Varianten.

FR

Modèle historique, présent dans la gamme Scolaro depuis près de 50 ans. La ligne classique, mais simple et essentielle, la rend adaptée à tous les environnements et inattaquable par les tendances de la mode. Produit le plus vendu et le plus populaire. Large gamme et variantes disponibles.

ES

Modelo histórico, presente en la gama Scolaro desde hace casi 50 años. La línea clásica, pero simple y esencial, la hace adecuada para todos los ambientes e invulnerable a las tendencias de la moda. Producto más vendido y más popular. Amplia gama y variantes disponibles.

NL

Het meest klassieke model in de Scolaro-collectie en al bijna 50 jaar in productie. De klassieke lijn, maar tegelijkertijd eenvoudig en essentieel maakt het geschikt voor alle omgevingen en ongevoelig voor modetrends. Ons meest verkochte model wereldwijd. In veel varianten en kleuren leverbaar.



IT
Telaio in legno Iroko selezionato,
trattato con vernice protettiva per esterni.

EN
Frame: Selected Iroko wood. Varnished
and treated.

DE
Gestell: Erstklassiges Irokoholz mit
umweltfreundlicher Schutzlasur.

FR
Armature: Bois Iroko sélectionné, traité
avec un vernis protecteur.

ES
Estructura: Iroko con recubrimientos
protectores para uso en exteriores.

NL
Mast en baleinen: Iroko.
Milieuvriendelijk behandeld.

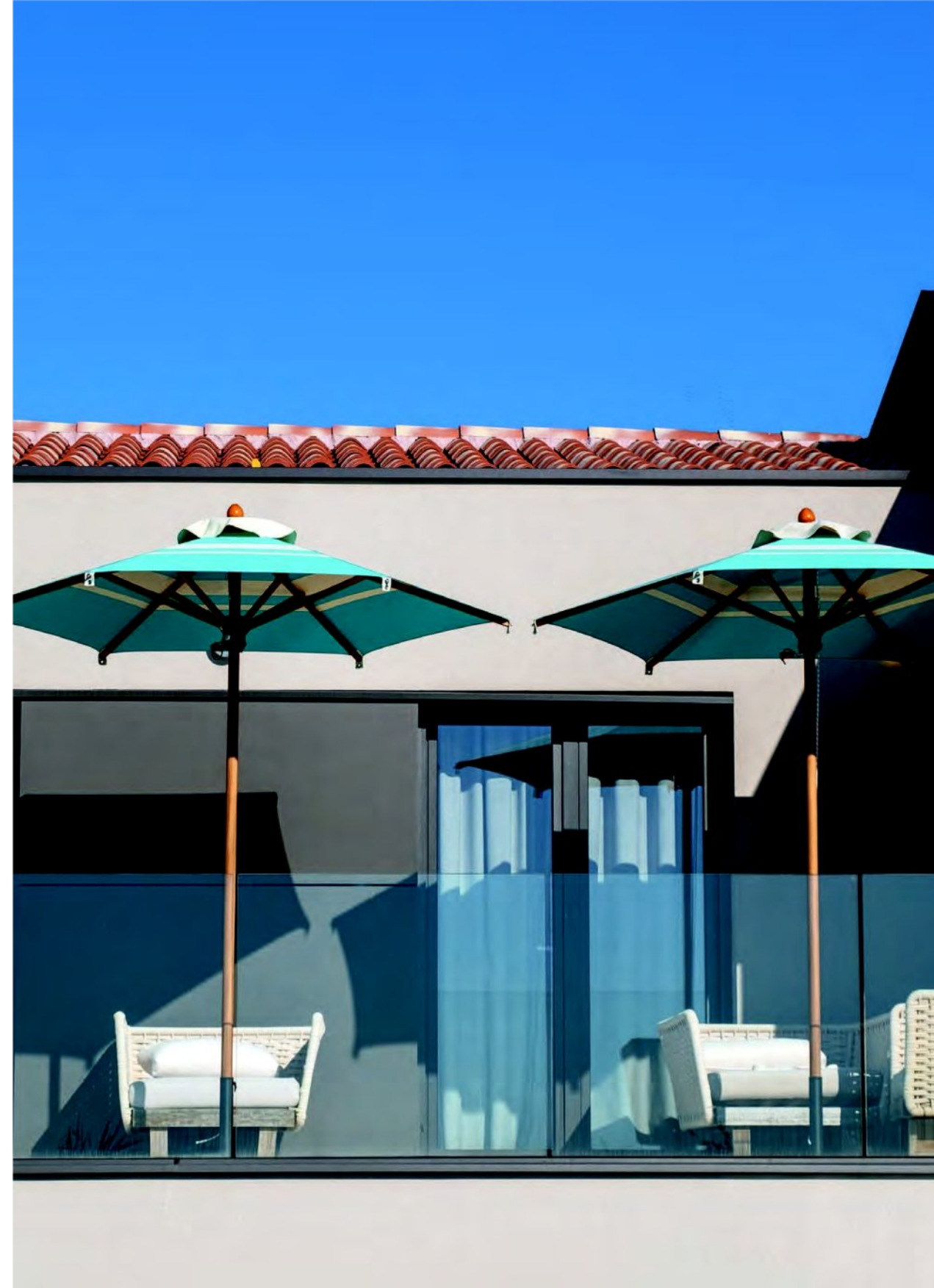



CHARACTERISTICS



2,5 C2500 PAS		10	0,09	38 48	6	18x30
3,0 C3000 PAS		17	0,10	48	8	18x34
3,5 C3500 PAS		18	0,10	48	8	18x34
4,0 C4000 PAS		23	0,17	58	8	18x34
2,0 x 2,0 C2020 PAS		10	0,09	48	4	18x34
3,0 x 3,0 C3030 PAS		20	0,11	48	8	18x34
3,5x3,5 C3535 PAS		25	0,17	58	8	18x34
4,0x4,0 C4040 PAS		31	0,17	58	8	20x34
2,0x3,0 C2030 PAS		16	0,14	48	6	18x34
3,0x4,0 C3040 PAS		26	0,12	58	8	18x34

BASES p. 186

BALLAST p. 194

GROUND FIXING p. 195

OPTIONAL

2,5 C2500 PAS	◆	BF6565D BF6565W	BC35MA4 BC55MA4	BC151GRA4	/	/	/	BTC +BTT45 /BTT55	CP3030ZS +BTT45 /BTT55
3,0 C3000 PAS	◆	BF6565D BF6565W	BC55MA4 BC80MA4	BC151GRA4	/	/	/	BTC +BTT55	CP3030ZS +BTT55
3,5 C3500 PAS	◆	BF6565D BF6666D BF6565W BF6666W	BC55MA4 BC80MA4	BC151GRA4	/	/	/	BTC +BTT55	CP3030ZS +BTT55
4,0 C4000 PAS	◆	BF6565D BF6666D BF6565W BF6666W	BC55MA4 BC80MA4	/	BQ8080ZS BQ8080DS	BUD8080DS	◆	BTC +BTT65	CP3030ZS +BTT65
2,0 x 2,0 C2020 PAS	◆	BF6565D BF6565W	BC35MA4 BC55MA4	BC151GRA4	/	/	/	BTC +BTT55	CP3030ZS +BTT55
3,0 x 3,0 C3030 PAS	◆	BF6565D BF6666D BF6565W BF6666W	BC55MA4 BC80MA4	BC151GRA4	BQ8080ZS BQ8080DS	BUD8080DS	◆	BTC +BTT55	CP3030ZS +BTT55
3,5x3,5 C3535 PAS	◆	BF6565D BF6666D BF6565W BF6666W	BC55MA4 BC80MA4	/	BQ8080ZS BQ8080DS	BUD8080DS	◆	BTC +BTT65	CP3030ZS +BTT65
4,0x4,0 C4040 PAS	◆	BF6565D BF6666D BF6565W BF6666W	BC80MA4	/	BQ8080ZS BQ8080DS	BUD8080DS	◆	BTC +BTT65	CP3030ZS +BTT65
2,0x3,0 C2030 PAS	◆	BF6565D BF6565W	BC55MA4 BC80MA4	BC151GRA4	/	/	/	BTC +BTT55	CP3030ZS +BTT55
3,0x4,0 C3040 PAS	◆	BF6565D BF6666D BF6565W BF6666W	BC55MA4 BC80MA4	/	BQ8080ZS BQ8080DS	BUD8080DS	◆	BTC +BTT65	CP3030ZS +BTT65

FINISHING

- Camino antivento
Wind cap
- Doppia Carrucola
Double pulley
- Iroko Wood

VERIFICA LA STABILITÀ - p.196

Check stability - Vérifiez la stabilité - Stabilität prüfen - Compruebe la estabilidad - Controleer de stabiliteit

COLOUR RANGE - p.204

ACRILYC 350GR

Con volante / with volant

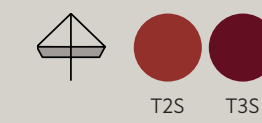

Senza volant / without volant





LEONARDO TELESCOPIC



Il sistema telescopico che permette l'apertura e la chiusura al di sopra di tavoli e sedie abbinato al telaio in alluminio rendono l'ombrellone Leonardo Telescopic resistente, leggero e di facile utilizzo.

EN

The telescopic opening system over tables and chairs combined with the employ of an aluminium frame grant strength, lightness and easy employ.





-  -
-  350x350 | 400x400
-  300x400

DE

Das teleskopische Oeffnungssystem oberhalb von Tischen und Stuehlen und das Aluminiumgestell machen aus diesem Schirm eine leichte jedoch starke und fuer einen gewerblichen Einsatz geeignete Version.

FR

L'ouverture telescopique au-dessus de tables et chaises font de ce article un parasol résistant, léger et apte pour un emploi professionnel.

ES

El sistema telescópico permite abrir y cerrar el parasol por encima de las mesas siendo de este modo un parasol resistente, ligero y de fácil uso.

NL

Dankzij het telescoopsysteem is het ook mogelijk bij grotere afmetingen parasols deze te sluiten boven de tafel. Zeer geschikt voor professioneel gebruik.



IT

Sistema di apertura telescopico.
Telaio: Alluminio verniciato a polveri colore antracite. Viteria in acciaio inox e componenti in nylon colore nero.

EN

Telescopic opening system. Frame: Aluminium powder coated anthracite grey. Stainless steel screws and components in black nylon.

DE

Teleskopoeffnungssystem Gestell:
Pulverbeschichtetes Aluminium Farbe Anthrazitgrau. Edelstahlschrauben und Zubehoer aus Nylon. Farbe schwarz.

FR

Ouverture telescopique Armature:
Aluminium vernis couleur gris anthracite. Visserie en inox et composants en nylon noir.

ES

Sistema de apertura telescópica. Mástil:
aluminio recubierto de color antracita.
Accesorios de nylon. Tornillo de aciere inox y componentes de nylon negro.

NL

Telescoop systeem voor het openen en sluiten van de parasol boven de tafel. Mast en baleinen: aluminium, antracietgrijs geëpoxeerd. Schroeven van RVS, overige bewegende delen zijn van nylon.



CHARACTERISTICS



<p>3,5 x 3,5 C3535 LET</p>	<p>25</p> <p>0,20</p> <p>55</p> <p>8</p> <p>18x35</p>
<p>4,0 x 4,0 C4040 LET</p>	<p>25</p> <p>0,20</p> <p>55</p> <p>8</p> <p>18x35</p>
<p>3,0 x 4,0 C3040 LET</p>	<p>20</p> <p>0,15</p> <p>55</p> <p>8</p> <p>18x30</p>

BASES p. 186

BALLAST p. 194

GROUND FIXING p. 195

OPTIONAL

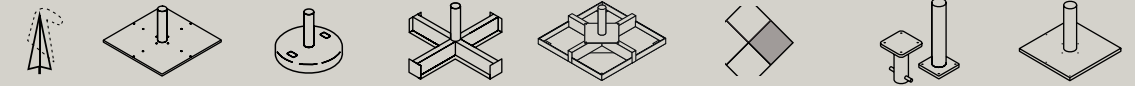

<p>3,5 x 3,5 C3535 LET</p>	◆	BF6666D	BC80MA4	BQ8080DS	BUD8080DS	◆	BTC +BTT65	CP3030ZS +BTT65
<p>4,0 x 4,0 C4040 LET</p>	◆	BF6666D	BC80MA4	BQ8080DS	BUD8080DS	◆	BTC +BTT65	CP3030ZS +BTT65
<p>3,0 x 4,0 C3040 LET</p>	◆	BF6565D BF6666D	BC80MA4	BQ8080DS	BUD8080DS	◆	BTC +BTT65	CP3030ZS +BTT65

68 FINISHING



• Camino antivento
Wind cap



• Sistema Telescopico
Telescopic system



• Stecca con sistema "easy change"
Ribs with "easy change" system



• Alu Dark



• Doppia Carrucola
Double pulley



• Alu Dark

COLOUR RANGE - p.204

ACRILYC 350GR

Con volante / with volant



A1S

ALL OPTIONS

Senza volant / without volant



A1N

ALL OPTIONS



T2S



T3S

ALL OPTIONS



T6N



T7N

ALL OPTIONS



T8N



T9N



S1N

VERIFICA LA STABILITÀ - p.196

Check stability - Vérifiez la stabilité - Stabilität prüfen - Compruebe la estabilidad - Controleer de stabiliteit



PALLADIO TELESCOPIC

La versione telescopica, progettata e sviluppata per prima da Scolaro, propone una apertura e chiusura dell'ombrellone facile e funzionale al di sopra di tavoli e sedie.

EN



The telescopic version Palladio, planned and developed first by Scolaro, offers an easy and functional opening and closing over tables and chairs.





72



-  500
-  400x400
-  300x400

DE

Die Teleskopversion Palladio, die Scolaro als Erster entwickelt und angeboten hat, bietet eine einfache und funktionelle Öffnung und Schliessung oberhalb von Tischen und Stuehlen an.

FR

La ligne Palladio télescopique, que Scolaro a projeté et développé par premier, offre une ouverture et fermeture facile et fonctionnel.

ES

La versión telescópica, planeada y desarrollada por la primera vez de Scolaro, propone una abertura y un cierre de la sombrilla fácil y funcional por encima de mesas y sillas.

NL

De telescoopversie, die Scolaro als eerste ontwikkeld heeft, biedt een eenvoudige oplossing om ook grote parasols (Ø 5,00 mtr.) boven de tafel te laten sluiten.

73



IT

Sistema di apertura telescopico. Telaio in legno Iroko selezionato, trattato con vernice protettiva per esterni.

EN

Telescopic opening system. Frame: Selected Iroko wood. Varnished and treated.

DE

Teleskopoeffnungssystem. Gestell: Erstklassiges Irokoholz mit umweltfreundlicher Schutzlasur.

FR

Ouverture telescopique. Armature: Bois Iroko sélectionné, traité avec un vernis protecteur.

ES

Sistema de apertura telescópica. Estructura: Iroko con recubrimientos protectores para uso en exteriores.

NL

Telescoop systeem voor het openen en sluiten van de parasol boven de tafel. Mast en baleinen: Iroko, milieuvriendelijk behandeld.



CHARACTERISTICS



5,0
C5000 PAT

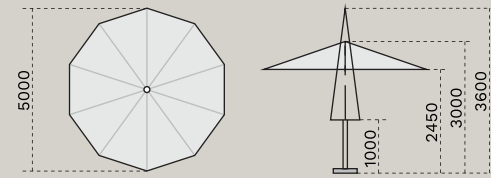

32 0,21 58 10 18x34

4,0 x 4,0
C4040 PAT

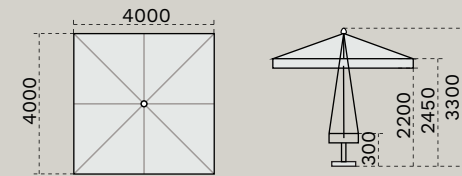

30 0,23 58 8 20x34

3,0 x 4,0
C3040 PAT

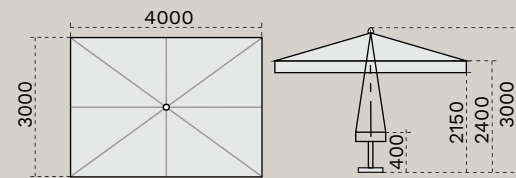

25 0,15 58 8 18x34

BASES p. 186

BALLAST p. 194

GROUND FIXING p. 195

OPTIONAL

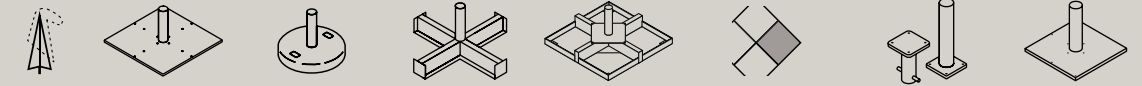

5,0
C5000 PAT



BF6666D
BF6666W

BC80MA4

BQ8080ZS
BQ8080DS

BUD8080BS
BUD8080DS



BTC
+BTT65

CP3030ZS
+BTT65

4,0 x 4,0
C4040 PAT



BF6666D
BF6666W

BC80MA4

BQ8080ZS
BQ8080DS

BUD8080BS
BUD8080DS



BTC
+BTT65

CP3030ZS
+BTT65

3,0 x 4,0
C3040 PAT



BF6565D
BF6666D
BF6565W
BF6666W

BC55MA4
BC80MA4

BQ8080ZS
BQ8080DS

BUD8080BS
BUD8080DS



BTC
+BTT65

CP3030ZS
+BTT65

76 FINISHING



• Camino antivento
Wind cap



• Sistema Telescopico
Telescopic system



• Doppia Carrucola
Double pulley



• Iroko Wood



• Iroko Wood

COLOUR RANGE - p.204

ACRILYC 350GR

Con volante / with volant



A1S

C4040 PAT

C3040 PAT

Senza volant / without volant



A1N

ALL OPTIONS



T2S



T3S

C4040 PAT

C3040 PAT



T6N



T7N

C4040 PAT

C3040 PAT



T8N



T9N



S1N



NAPOLI BRACCIO

La praticità della soluzione a braccio laterale interamente in acciaio e alluminio verniciato antracite mantiene il design raffinato inalterato nel tempo.

EN

Handy cantilever parasol entirely made of epoxy lacquered steel and aluminium, keeps its refined design unchanged.





80



DE

Praktischer Seitenarmschirm aus pulverbeschichtetem Stahl und Aluminium. Unveränderliches und raffiniertes Design.

FR

Parasol pratique avec bras excentré en acier et aluminium vernis qui n'altère en rien le design.



ES

Práctica sombrilla completamente fabricada en acero y aluminio lacados, reservado para diseños inalterados y refinados.

NL

Dankzij het telescoopsysteem is het ook mogelijk bij grotere afmetingen parasols deze te sluiten boven de tafel. Zeer geschikt voor professioneel gebruik.

81

-  350
-  300x300
-  200x300 | 300x200 | 300x400

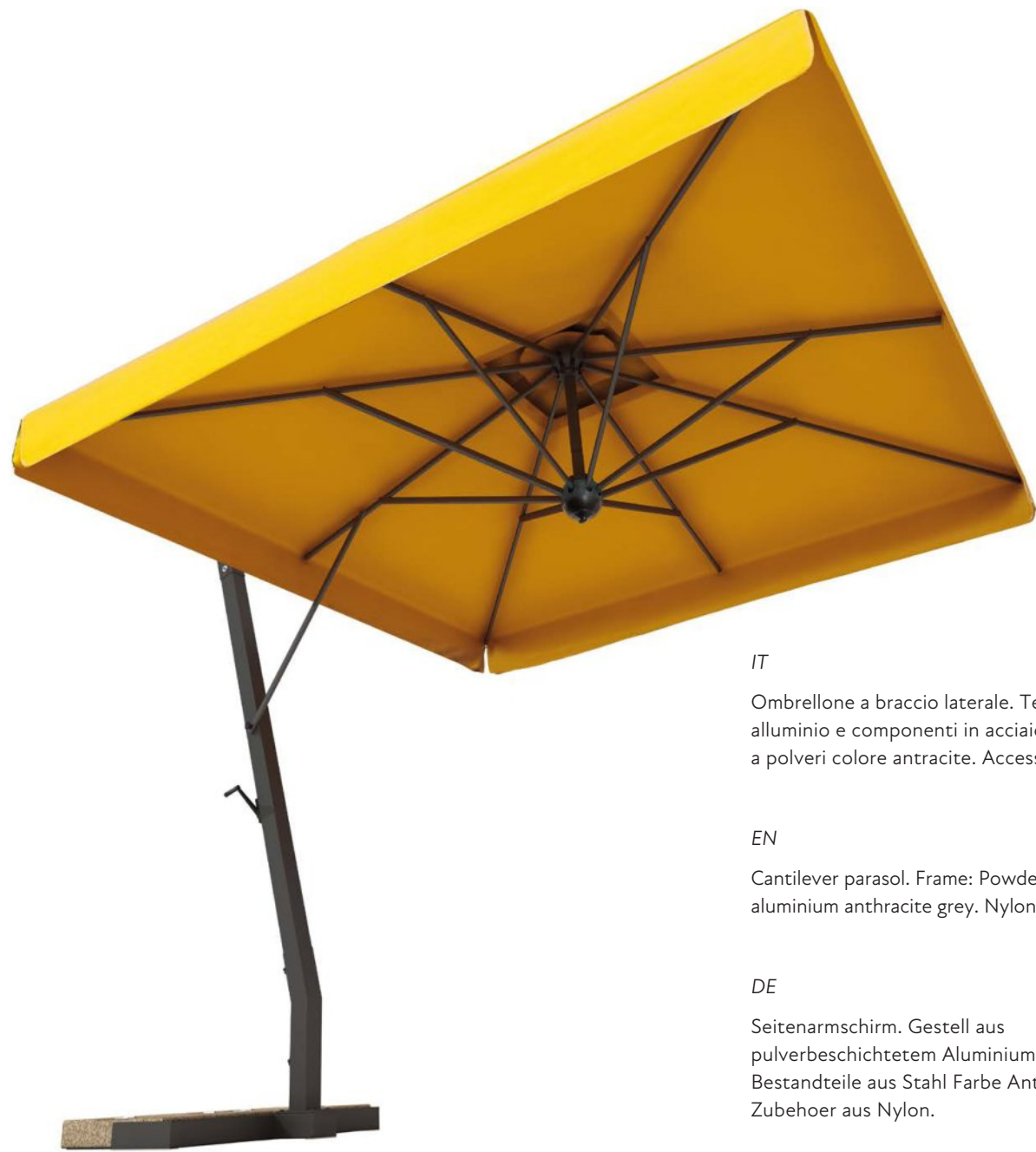

IT
 Ombrellone a braccio laterale. Telaio in alluminio e componenti in acciaio; verniciato a polveri colore antracite. Accessori in nylon.

EN
 Cantilever parasol. Frame: Powder coated aluminium anthracite grey. Nylon accessories.

DE
 Seitenarmschirm. Gestell aus pulverbeschichtetem Aluminium und Bestandteile aus Stahl Farbe Anthrazitgrau. Zubehoer aus Nylon.

FR
 Parasol bras deporté. Armature en aluminium vernis, composants en acier couleur gris anthracite. Accessoires en nylon.

ES
 Parasol de brazo lateral. Herraje: aluminio y componentes de acero, recubierto con polvo de antracita. Accesorios de nylon.

NL
 Vrijhangende parasol. Mast en baleinen: grijs geëpoxeerd aluminium en staal.



CHARACTERISTICS



3,5
C3500 NAB

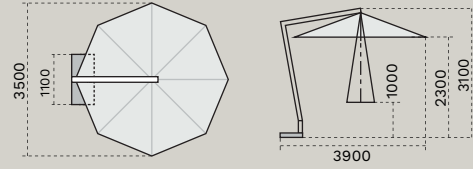

50 0,20 75x75 8 18x30

3,0 x 3,0
C3030 NAB

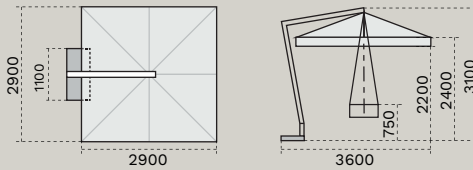

50 0,20 75x75 8 18x30

2,0 x 3,0
C2030 NAB

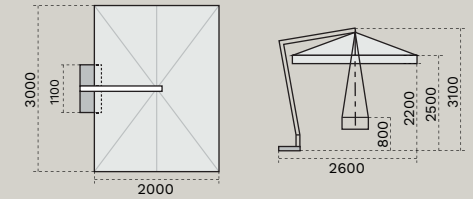

48 0,20 75x75 6 18x30

3,0 x 2,0
C3020 NAB

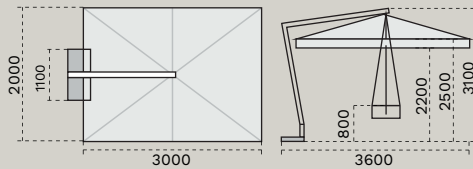

48 0,20 75x75 6 18x30

3,0 x 4,0
C3040 NAB

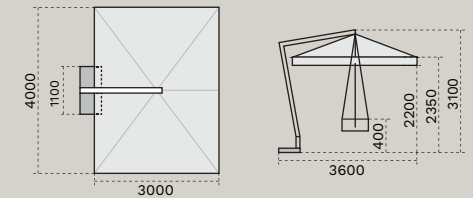

52 0,21 75x75 8 18x30

FINISHING



• Camino antivento
Wind cap



• Alu Dark



• Con meccanismo manovella
With winding mechanism



• Stecca con sistema "easy change"
Ribs with "easy change" system



• Alu Dark



• Inclinazione fino a 20°
Inclination up to 20°



• Blocco antivento
Wind stop

INOX

• Viteria in inox
Screws in Stainless steel

Not available for C3020NAB



• Ombrellone girevole a 360°
360-degree rotating umbrella

OPTIONAL

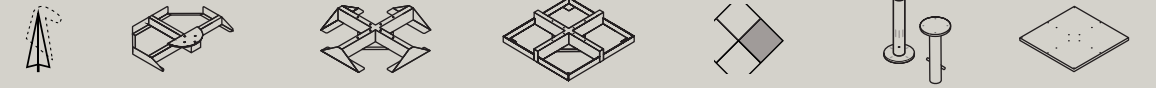

	BASES p. 186	BALLAST p. 194	GROUND FIXING p. 195
3,5 C3500 NAB	◆ B1DS	◆ PL1DS	◆ BUD8080DS
3,0 x 3,0 C3030 NAB	◆ B1DS	◆ PL1DS	◆ BUD8080DS
2,0 x 3,0 C2030 NAB	◆ B1DS	◆ PL1DS	◆ BUD8080DS
3,0 x 2,0 C3020 NAB	◆ B1DS	◆ PL1DS	◆ BUD8080DS
3,0 x 4,0 C3040 NAB	◆ B1DS	◆ PL1DS	◆ BUD8080DS

Base non compresa nel prezzo | Base not included in the price

COLOUR RANGE - p.204

ACRILYC 350GR

Con volante / with volant



A1S

- C3040 NAB
- C2030 NAB
- C3020 NAB
- C3040 NAB

Senza volant / without volant



A1N

ALL OPTIONS



T2S



T3S

- C3030 NAB
- C3040 NAB



T6N



T7N

- C3500 NAB
- C3030 NAB
- C3040 NAB



T8N



T9N



S1N

VERIFICA LA STABILITÀ - p.196

Check stability - Vérifiez la stabilité - Stabilität prüfen - Compruebe la estabilidad - Controleer de stabiliteit



RIMINI BRACCIO

Modello con struttura in alluminio verniciata a polveri epossidiche con rinnovato colore Starwhite.
Si inserisce perfettamente in ambienti moderni e ricercati.

EN

Parasol with aluminium frame epoxy coated with renewed Starwhite color. It fits perfectly into modern and sophisticated environments.





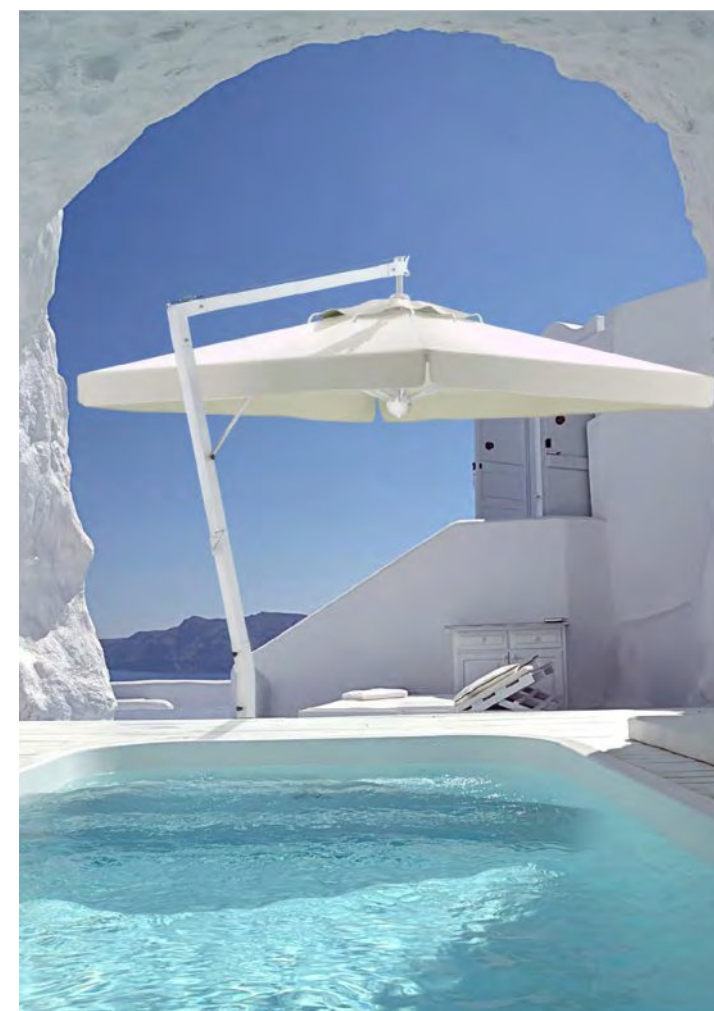

88



89

-  350
-  300x300
-  300x400

DE

Schirm mit Aluminiumgestell pulverbeschichtet Farbe Starwhite. Besonders fuer moderne und anspruchsvolle Mileux geeignet.

FR

Modèle avec armature en aluminium vernis couleur Starwhite. Il s'intègre parfaitement dans les environnements modernes et sophistiqués.

ES

Modelo con estructura de aluminio pintada con polvo epoxi color Starwhite. Se introduce perfectamente en ambientes modernos y de diseño.

NL

Parasol met gepoedercoat aluminium frame kleur Starwhite. Past perfect in een moderne en stijlvolle omgeving.



IT

Ombrellone a braccio laterale.
Telaio: alluminio e componenti in acciaio;
verniciato a polveri colore Starwhite.
Accessori in nylon.

EN

Cantilever parasol.
Frame: powder coated aluminium and
steel components Starwhite. Nylon accessories.

DE

Pendelschirm. Gestell aus
pulverbeschichtetem Aluminium.
Bestandteile aus Stahl Farbe Starwhite
Zubehoer aus Nylon.

FR

Parasol bras déporté.
Armature en aluminium vernis, composants
en acier couleur Starwhite. Accessoires en
nylon.

ES

Parasol con brazo lateral.
Estructura: aluminio y componentes de
acero, recubierto con polvo color Starwhite.
Accesorios de nylon.

NL

Vrijhangende parasol. Mast en baleinen:
Starwhite geëpoxeerd aluminium en staal.



CHARACTERISTICS



3,5
C3500 RIB

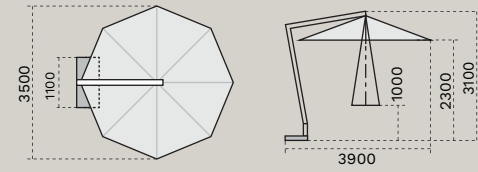

50 0,20 75x75 8 18x30

3,0 x 3,0
C3030 RIB

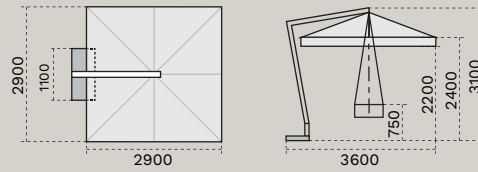

50 0,20 75x75 8 18x30

3,0 x 4,0
C3040 RIB

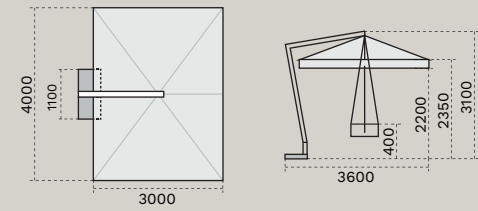

52 0,21 75x75 8 18x30

OPTIONAL

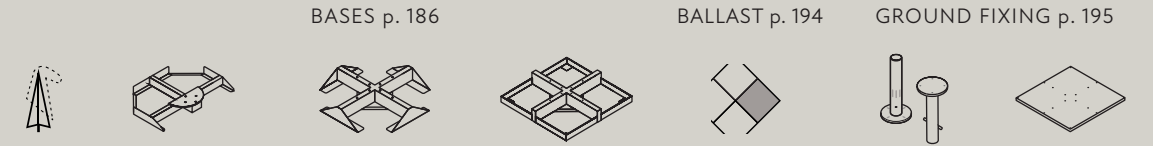

3,5
C3500 RIB



B1BS

PL1BS

BUD8080BS



BTAZS

CP3030ZS
CP6565ZS

3,0 x 3,0
C3030 RIB



B1BS

PL1BS

BUD8080BS



BTAZS

CP3030ZS
CP6565ZS

3,0 x 4,0
C3040 RIB



B1BS

PL1BS

BUD8080BS



BTAZS

CP3030ZS
CP6565ZS

Base non compresa nel prezzo | Base not included in the price

92 FINISHING



• Camino antivento
Wind cap



• Ombrellone girevole a 360°C
360-degree rotating umbrella

INOX

• Viteria in inox
Screws in Stainless steel



• Stecca con sistema "easy change"
Ribs with "easy change" system



• Starwhite



• Con meccanismo manovella
With winding mechanism



• Blocco antivento
Wind stop



• Starwhite



• Inclinazione fino a 20°
Inclination up to 20°

COLOUR RANGE - p.204

ACRILYC 350GR

Con volante / with volant



A1S

C3030 RIB

C3040 RIB

Senza volant / without volant



A1N

ALL OPTIONS



T2N

T3N

C3500 RIB



T2S

T3S

C3030 RIB

C3040 RIB



T6N

T7N

ALL OPTIONS



T8N

T9N

S1N

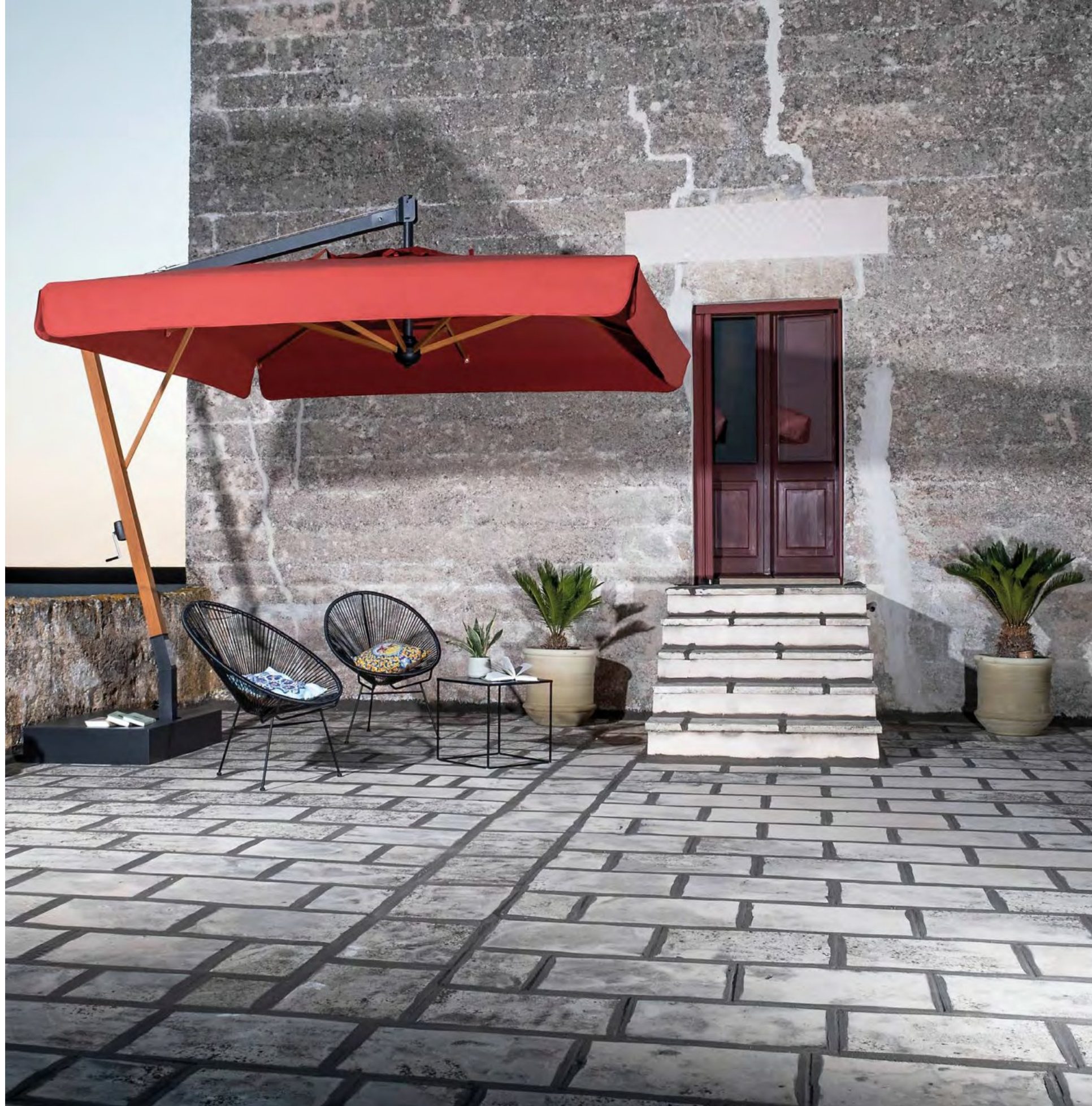

TORINO BRACCIO

Un grande classico caratterizzato dall'impiego del legno. Sostegno in alluminio con finitura legno che ne migliora le prestazioni senza alterarne l'estetica.

EN



A great classic characterized by the employ of wood. Aluminium support with wood finishing that improves the performance without altering the aesthetics.





96



-  350
-  300x300
-  200x300 | 300x200 | 300x400

DE

Ein grosser Klassiker aus Holz. Der Alumast mit Holzeffekt verbessert die Leistung ohne die Aesthetik des Schirmes zu veraendern.

FR

Un grand classique caractérisé par l'utilisation du bois. Le mât en aluminium avec une belle finition bois qui améliore les qualités du parasol sans en altérer l'esthétique et le design.

ES

Un gran clásico caracterizado por el uso de la madera. El soporte de aluminio con acabado de madera que mejora el rendimiento sin alterar la estética.

NL

Een houten klassieker. De aluminium mast met hout-look verbetert de kwaliteit zonder dat die de uitstraling van de parasol verandert.

97



IT

Ombrellone braccio laterale.
Sostegno in alluminio finitura legno Iroko.
Stecche in legno Iroko. Componenti in alluminio
e acciaio verniciato a polveri colore antracite.
Accessori in nylon.

EN

Cantilever parasol. Aluminium support provided
with Iroko wood finishing, Iroko wood ribs and
aluminium components epoxy coated colour
anthracite grey.

DE

Seitenarmschirm. Alumast mit
Irokoholoptik. Streben aus Irokoholz.
Alu- und Stahlbestandteile aus Aluminium
pulverbeschichtet Farbe Anthrazitgrau.

FR

Parasol bras lateral. Mat en aluminium avec
finition bois Iroko. Baleine en bois Iroko.
Composants en aluminium laqué gris.

ES

Parasol brazo lateral. Con soporte en aluminio
con acabados imitación madera, varillas de
madera de Iroko y componentes en aluminio
y acero pintados en polvo color antracita.
Accesorios en nylon.

NL

Vrijhangende parasol. Mast en aluminium
met Iroko uitstraling. Baleinen van Iroko
hout. Overige metalen delen grijs geepoxideerd
staal.

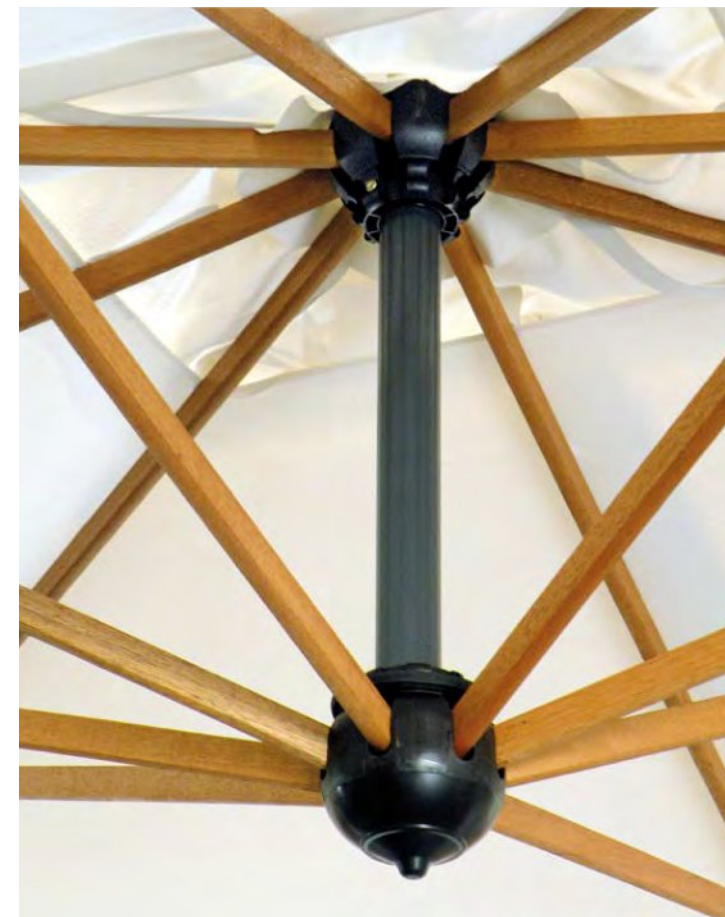

CHARACTERISTICS



3,5
C3500 TOB

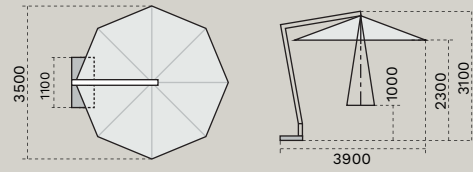

50 0,20 75x75 8 18x34

3,0 x 3,0
C3030 TOB

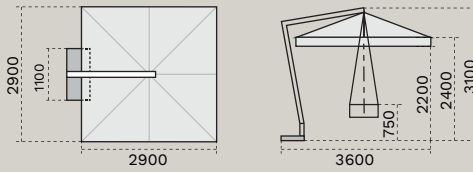

50 0,20 75x75 8 18x34

2,0 x 3,0
C2030 TOB

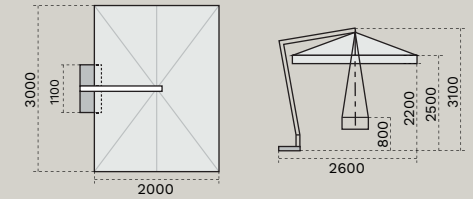

48 0,20 75x75 6 18x34

3,0 x 2,0
C3020 TOB

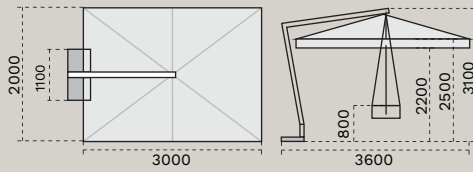

48 0,20 75x75 6 18x34

3,0 x 4,0
C3040 TOB

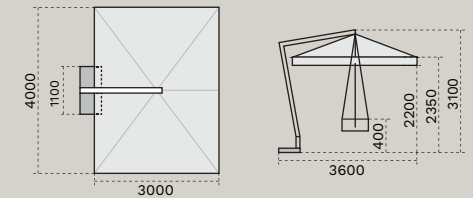

55 0,21 75x75 8 18x34

FINISHING



• Camino antivento
Wind cap



• Ombrellone girevole a 360°C
360-degree rotating umbrella

INOX

• Viteria in inox
Screws in Stainless steel



• Stecca con sistema "easy change"
Ribs with "easy change" system



• Alu Iroko / Dark



• Con meccanismo manovella
With winding mechanism



• Blocco antivento
Wind stop



• Iroko Wood



• Inclinazione fino a 20°
Inclination up to 20°

Not available for C3020 TOB

OPTIONAL

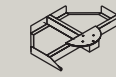

BASES p. 186

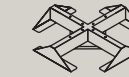

BALLAST p. 194



GROUND FIXING p. 195



3,5
C3500 TOB



B1DS

PL1DS

BUD8080DS



BTAZS

CP3030ZS
CP6565ZS

3,0 x 3,0
C3030 TOB



B1DS

PL1DS

BUD8080DS



BTAZS

CP3030ZS
CP6565ZS

2,0 x 3,0
C2030 TOB



B1DS

PL1DS

BUD8080DS



BTAZS

CP3030ZS
CP6565ZS

3,0 x 2,0
C3020 TOB



B1DS

PL1DS

BUD8080DS



BTAZS

CP3030ZS
CP6565ZS

3,0 x 4,0
C3040 TOB



B1DS

PL1DS

BUD8080DS



BTAZS

CP3030ZS
CP6565ZS

Base non compresa nel prezzo | Base not included in the price

COLOUR RANGE - p.204

ACRILYC 350GR

Con volante / with volant



A1S

C3030 TOB

C2030 TOB

C3020 TOB

C3040 TOB



T2S



T3S

C3030 TOB

C3040 TOB

Senza volant / without volant



A1N

ALL OPTIONS



T2N



T3N

C3500 TOB



T6N



T7N

C3500 TOB

C3030 TOB

C3040 TOB



T8N



T9N



S1N

VERIFICA LA STABILITÀ - p.196

Check stability - Vérifiez la stabilité - Stabilität prüfen - Compruebe la estabilidad - Controleer de stabiliteit



LEONARDO BRACCIO

Ombrellone a braccio in alluminio verniciato a polveri epossidiche colore grigio antracite. Molto apprezzato da sempre per la struttura robusta e adatta per un uso intenso professionale.

EN



Cantilever parasol in aluminum with epoxy coated frame color Anthracite Grey. Since ever particularly appreciated for the strong structure and suitable for a heavy professional employ.





104



-  400
-  300x300 | 350x350 | 400x400
-  300x400

DE

Seitenarmschirm aus Aluminium Anthrazitgrau pulverbeschichtet. Seit immer besonders fuer die Stabilitaet geschaezt. Auch fuer einen gewerblichen Einsatz geeignet.

FR

Parasol avec bras deporté en aluminium vernis gris anthracite. Toujours apprécié pour sa structure robuste et adapte à un usage professionnel intensif.

ES

Parasol de palo lateral pintado con polvo epoxi en color antracita. Muy valorado desde siempre por la estructura robusta y adecuada para un uso profesional intenso.

NL

Vrijhangende parasol van gepoedercoat aluminium in antracietgrijs. Al jarenlang populair vanwege de goede stabiliteit. Ook geschikt voor gebruik in de horeca.

105



IT

Ombrellone a braccio laterale robusto.
Telaio: Alluminio e componenti in acciaio;
verniciato a polveri colore antracite.
Accessori in nylon.

EN

Strong cantilever parasol. Frame: Powder coated
aluminium anthracite grey. Nylon accessories.

DE

Starker Pendelschirm. Gestell aus
pulverbeschichtetem Aluminium Farbe
Anthrazitgrau. Zubehoer aus Nylon.

FR

Parasol bras deporté robuste. Armature:
Aluminium vernis couleur gris anthracite.
Accessoires en nylon.

ES

Brazo lateral resistente. Estructura: aluminio
y piezas de acero, recubierto con polvo de
antracita. Accesorios de nylon.

NL

Robuuste vrijhangende parasol. Mast en
baleinen: grijs geëpoxeerd aluminium en
staal.



CHARACTERISTICS



4,0
C4000 LEB

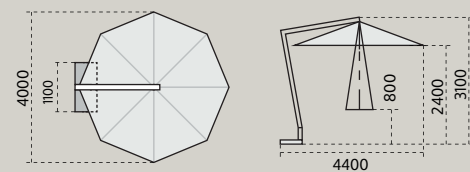

68 0,35 92x92 8 18x30

3,0 x 3,0
C3030 LEB

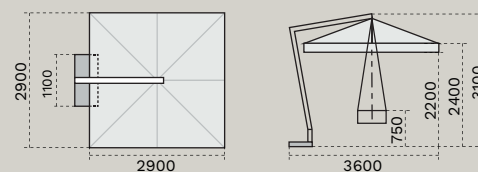

68 0,35 92x92 8 18x30

3,5 x 3,5
C3535 LEB

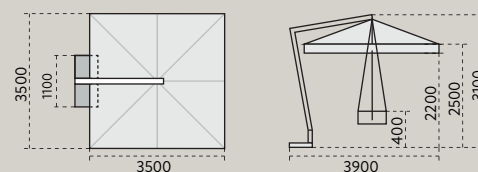

70 0,36 92x92 8 18x30

4,0 x 4,0
C4040 LEB

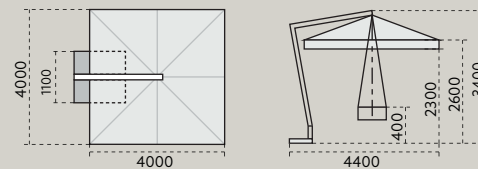

100 0,48 92x92 8 18x35

3,0 x 4,0
C3040 LEB

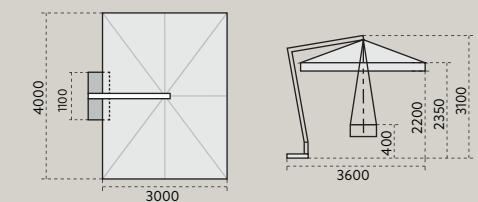

70 0,36 92x92 8 18x30

FINISHING



• Camino antivento
Wind cap



• Ombrellone girevole a 360°C
360-degree rotating umbrella

INOX

• Viteria in inox
Screws in Stainless steel



• Stecca con sistema "easy change"
Ribs with "easy change" system



• Alu Dark



• Con meccanismo manovella
With winding mechanism



• Blocco antivento
Wind stop



• Alu Dark



• Inclinazione fino a 20°
Inclination up to 20°

BASES p. 186

BALLAST p. 194

GROUND FIXING p. 195

OPTIONAL

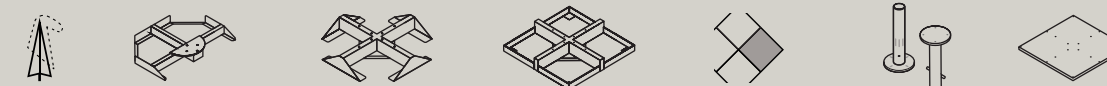

4,0
C4000 LEB



B1DS

PL1DS

BUD8080DS



BTAZS

CP3030ZS
CP6565ZS

3,0 x 3,0
C3030 LEB



B1DS

PL1DS

BUD8080DS



BTAZS

CP3030ZS
CP6565ZS

3,5 x 3,5
C3535 LEB



B1DS

PL1DS

BUD8080DS



BTAZS

CP3030ZS
CP6565ZS

4,0 x 4,0
C4040 LEB



/

PL1DS

/



BTAZS

CP3030ZS
CP6565ZS

3,0 x 4,0
C3040 LEB



B1DS

PL1DS

BUD8080DS



BTAZS

CP3030ZS
CP6565ZS

Base non compresa nel prezzo | Base not included in the price

COLOUR RANGE - p.204

ACRILYC 350GR

Con volante / with volant



A1S

C3030 LEB

C3535 LEB

C4040 LEB

C3040 LEB

Senza volant / without volant



A1N

ALL OPTIONS



T2S



T3S

C3030 LEB

C3535 LEB

C4040 LEB

C3040 LEB



T6N



T7N

C3030 LEB

C3535 LEB

C4040 LEB

C3040 LEB



T8N



T9N



S1N

VERIFICA LA STABILITÀ - p.196

Check stability - Vérifiez la stabilité - Stabilität prüfen - Compruebe la estabilidad - Controleer de stabiliteit



POMPEI BRACCIO

Ombrellone a braccio laterale in alluminio verniciato a polveri epossidiche colore Starwhite. Versione particolarmente elegante, creata anche per ambienti esclusivi. Ombrellone robusto e adatto per un uso intenso professionale.

EN

Cantilever parasol in aluminum with epoxy coated frame color Starwhite. Particularly elegant version also fitting with exclusive environments. Strong parasol suitable for a heavy professional employ.





DE

Schirm aus Aluminium Starwhite pulverbeschichtet. Elegante Version auch fuer besondere Milieux gedacht. Stabiler Schirm, geeignet fuer einen gewerblichen Einsatz.

FR

Parasol avec bras déporté en aluminium vernis Starwhite. Version particulièrement élégante, également créée pour des environnements exclusifs. Parasol robuste adapté à un usage professionnel intensif.



ES

Parasol con palo lateral en aluminio pintado con polvo epoxi de color Starwhite. Versión particularmente elegante, creada también para ambientes exclusivos. Parasol robusto y adecuado para un uso profesional intenso.

NL

Vrijhangende parasol met gepoedercoat Starwhite frame. Elegante uitvoering die uitermate geschikt is voor een exclusieve omgeving. Sterke parasol die ook geschikt is voor de horeca.



-  -
-  300x300 | 350x350
-  300x400



IT
Ombrellone a braccio laterale robusto.
Struttura in alluminio con verniciatura
a polveri epossidiche colore Starwhite.

EN
Strong cantilever parasol. Aluminum
frame epoxy coated Starwhite.

DE
Starker Seitenarmschirm. Gestell aus
Aluminium pulverbeschichtet Starwhite.

FR
Parasol avec bras deporté robuste.
Armature en aluminium vernis Starwhite.

ES
Parasol de palo lateral robusto. Estructura
de aluminio pintada con polvo epoxi en color
Starwhite.

NL
Sterke vrijhangende parasol. Frame van
gepoedercoat aluminium in de kleur Starwhite.



CHARACTERISTICS



3,0x3,0
C3030 PMB

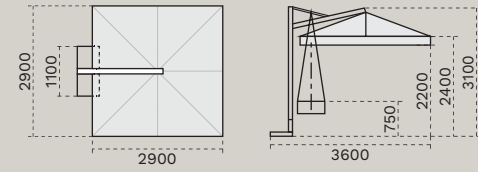

75 0,35 92x92 8 18x30

3,5 x 3,5
C3535 PMB

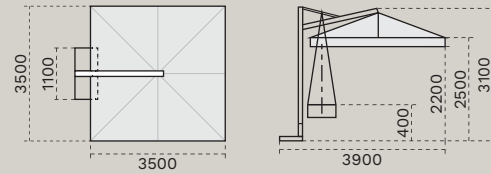

80 0,36 92x92 8 18x30

3,0 x 4,0
C3040 PMB

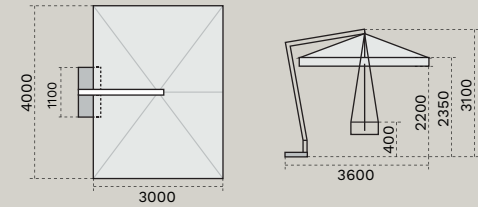

80 0,36 92x92 8 18x30

BASES p. 186

BALLAST p. 194

GROUND FIXING p. 195

OPTIONAL

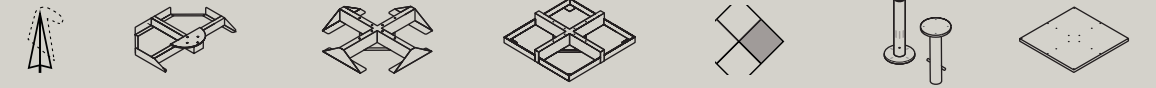

3,0x3,0
C3030 PMB

◆ B1BS PL1BS BUD8080BS ◆ BTAZS CP3030ZS CP6565ZS

3,5 x 3,5
C3535 PMB

◆ B1BS PL1BS BUD8080BS ◆ BTAZS CP3030ZS CP6565ZS

3,0 x 4,0
C3040 PMB

◆ B1BS PL1BS BUD8080BS ◆ BTAZS CP3030ZS CP6565ZS

Base non compresa nel prezzo | Base not included in the price

116 FINISHING



• Camino antivento
Wind cap



• Ombrellone girevole a 360°C
360-degree rotating umbrella

INOX

• Viteria in inox
Screws in Stainless steel



• Stecca con sistema "easy change"
Ribs with "easy change" system



• Starwhite



• Con meccanismo manovella
With winding mechanism



• Blocco antivento
Wind stop



• Starwhite



• Inclinazione fino a 20°
Inclination up to 20°

COLOUR RANGE - p.204

ACRILYC 350GR

Con volante / with volant



A1S

ALL OPTIONS



T2S



T3S

ALL OPTIONS

Senza volante / without volant



A1N

ALL OPTIONS



T6N



T7N

ALL OPTIONS



T8N



T9N



S1N

VERIFICA LA STABILITÀ - p.196

Check stability - Vérifiez la stabilité - Stabilität prüfen - Compruebe la estabilidad - Controleer de stabiliteit



PALLADIO BRACCIO



Modello di ombrellone prodotto da Scolaro da oltre 30 anni opportunamente aggiornato nel tempo. Dimostra l'ottima progettazione iniziale e riassume la tradizione ed esperienza nel settore, confermato anche dalle migliaia di unità vendute in tutto il mondo. Sostegno verticale previsto in alluminio con speciale finitura effetto legno ancora più robusto e duraturo.

EN

Model produced by Scolaro since over 30 years opportunely renewed. Thousand of pieces sold worldwide, of which many are still employed, are the proof of an optimal planning and that this item sums up tradition and experience in the branch. Vertical aluminium support provided with special wood finishing for an unalterable design.





-  350
-  300x300 | 350x350
-  300x400

DE

Scolaro stellt dieses Model seit ueber 30 Jahren her und hat es mit der Zeit stets erneuert und verbessert. Die tausenden Teile, die weltweit verkauft wurden und stets noch eingesetzt werden sind der Beweis einer optimalen Planung und der erfolgreichen Kombination von Tradition und Erfahrung in der Branche. Alumast mit spezieller Holzoptik. Unveraenderliches Design.

FR

Modèle de parasol fabriqué par Scolaro depuis plus de 30 ans et relooké. Les milliers de pièces vendus dans le monde sont la preuve de la qualité, robustesse et succès que connaît le modèle Palladio et du professionnalisme de la ste Scolaro. Mat vertical en aluminium avec finition effet bois permettant un design inchangé.

ES

Modelo fabricado por Scolaro desde hace 30 años, oportunamente renovado. Se vendieron miles de piezas (sombrellas) por todo el mundo, de las cuales muchas aún son utilizadas, y esto es la prueba de que este artículo resume la tradición y la experiencia en el sector. Soporte vertical fabricado en aluminio con acabados especiales imitación madera, lo hacen más robusto y duradero.

NL

Dit model wordt door Scolaro al meer dan 30 jaar op de markt gebracht en is gedurende die tijd steeds aan de actualiteit aangepast. De vele duizenden die er in de afgelopen jaren wereldwijd verkocht zijn, leveren het bewijs voor uitstekende kwaliteit; dit dankzij de succesvolle combinatie van vakmanschap en ervaring. Aluminium mast met unieke essenhout uitstraling. Solide zwevende designparasol. Met nieuwe aluminium mast met uniek Iroko houten uitstraling.



IT

Ombrellone a braccio laterale robusto. Sostegno in alluminio con finitura legno, stecche in legno Iroko, componenti in alluminio e acciaio verniciato a polveri colore antracite. Accessori in nylon.

EN

Strong cantilever parasol. Aluminium support provided with Iroko wood finishing, Iroko wood ribs and aluminium components epoxy coated colour anthracite grey.

DE

Starker Seitenarmschirm. Alumast mit Holzoptik. Streben aus Irokoholz. Alu und Stahlbestandteile aus Aluminium pulverbeschichtet Farbe Anthrazitgrau.

FR

Parasol a bras lateral robuste. Mat en aluminium avec finition bois Iroko. Baleine en bois Iroko. Composants en aluminium laqué gris.

ES

El parasol brazo lateral es robusto. Con soporte en aluminio con acabados imitación madera, varillas de madera de Iroko y componentes en aluminio y acero pintados en polvo color antracita. Accesorios en nylon.

NL

Robuust Vrijhangende parasol. Mast en aluminium met Iroko uitstraling. Baleinen van Iroko hout. Overige metalen delen grijs geepoxeerd staal.



CHARACTERISTICS



3,5
C3500 PAB

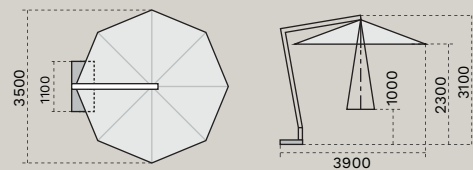

75 0,35 92x92 8 18x34

3,0 x 3,0
C3030 PAB

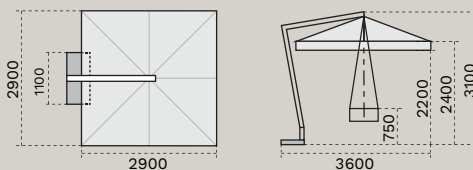

75 0,35 92x92 8 18x34

3,5 x 3,5
C3535 PAB

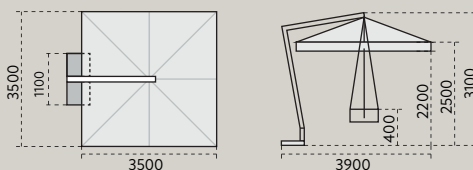

80 0,36 92x92 8 18x34

3,0 x 4,0
C3040 PAB

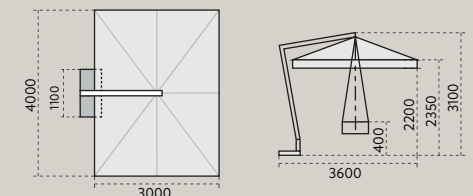

80 0,36 92x92 8 18x34

FINISHING



• Camino antivento
Wind cap



• Ombrellone girevole a 360°
360-degree rotating umbrella

INOX

• Viteria in inox
Screws in Stainless steel



• Stecca con sistema "easy change"
Ribs with "easy change" system



• Alu Iroko / Dark



• Con meccanismo manovella
With winding mechanism



• Blocco antivento
Wind stop



• Iroko Wood



• Inclinazione fino a 20°
Inclination up to 20°

OPTIONAL

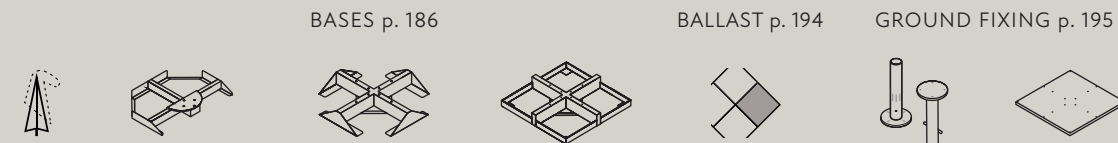

3,5
C3500 PAB

◆ B1DS PL1DS BUD8080DS ◆ BTAZS CP3030ZS CP6565ZS

3,0 x 3,0
C3030 PAB

◆ B1DS PL1DS BUD8080DS ◆ BTAZS CP3030ZS CP6565ZS

3,5 x 3,5
C3535 PAB

◆ B1DS PL1DS BUD8080DS ◆ BTAZS CP3030ZS CP6565ZS

3,0 x 4,0
C3040 PAB

◆ B1DS PL1DS / ◆ BTAZS CP3030ZS CP6565ZS

Base non compresa nel prezzo | Base not included in the price

COLOUR RANGE - p.204

ACRILYC 350GR

Con volante / with volant



A1S

C3030 PAB

C3535 PAB

C3040 PAB



T2S



T3S

C3030 PAB

C3535 PAB

C3040 PAB

Senza volant / without volant



A1N

ALL OPTIONS



T2N



T3N

C3500 PAB



T6N



T7N

C3500 PAB

C3030 PAB

C3535 PAB

C3040 PAB



T8N



T9N



S1N

VERIFICA LA STABILITÀ - p.196

Check stability - Vérifiez la stabilité - Stabilität prüfen - Compruebe la estabilidad - Controleer de stabiliteit



GALILEO DARK

Ombrellone con sistema di apertura retrattile permette la facile chiusura dell'ombrellone anche in presenza di arredo. Si tratta del migliore sistema presente nel mercato perché Scolaro, nel progettare e sviluppare ha tenuto conto di: apertura e inclinazione facilitata, estetica, molta attenzione nel prevedere eventuale assistenza o facile riparazione anche ad opera dell'utente finale. Il sistema di inclinazione progettato indipendente dall'apertura e chiusura rende questo modello la migliore soluzione presente nel mercato.

EN

Parasol with opening system close on the support that allows an easy closing of the parasol without moving the furniture. It's the best system on the market that Scolaro has developed considering: functionality of the system, aesthetics, special attention in foreseeing a possible assistance or easy restore by the final customer. The inclination system is planned independently from the opening and closing and makes therefore this model the best solution in the market.



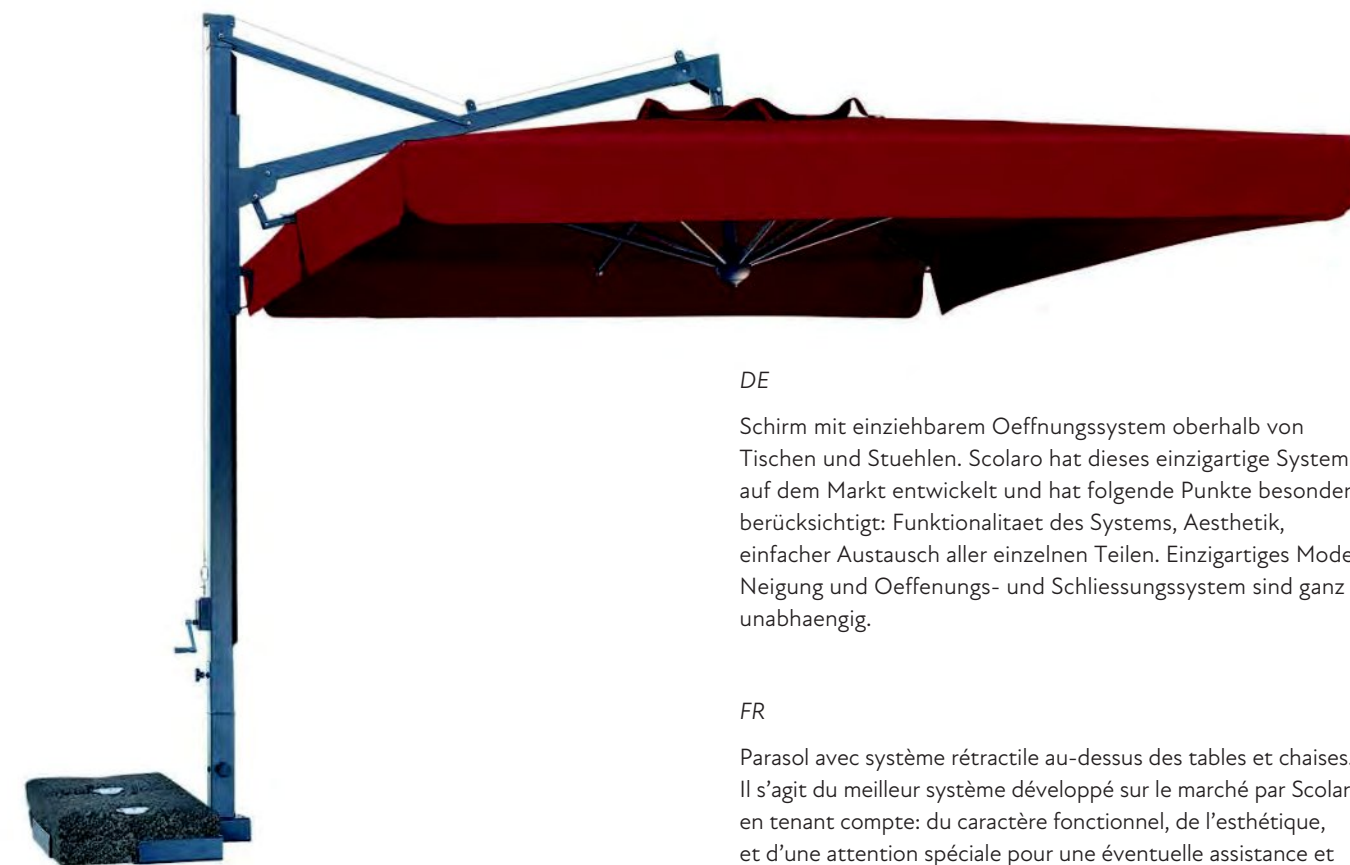

DE

Schirm mit einziehbarem Öffnungssystem oberhalb von Tischen und Stuehlen. Scolaro hat dieses einzigartige System auf dem Markt entwickelt und hat folgende Punkte besonders berücksichtigt: Funktionalitaet des Systems, Aesthetik, einfacher Austausch aller einzelnen Teile. Einzigartiges Model. Neigung und Öffnungs- und Schliessungssystem sind ganz unabhaengig.

FR



Parasol avec système rétractile au-dessus des tables et chaises. Il s'agit du meilleur système développé sur le marché par Scolaro en tenant compte: du caractère fonctionnel, de l'esthétique, et d'une attention spéciale pour une éventuelle assistance et réparation de la part de l'utilisateur final. Le système d'inclinaison conçu indépendamment de l'ouverture et de la fermeture rend ce modèle la meilleure solution sur le marché.

ES

Parasole con sistema de apertura retráctil, permite el cierre fácil de la sombrilla, sin mover el mueble. Este es el mejor sistema del mercado que Scolaro ha desarrollado teniendo en cuenta: Funcionalidad del sistema, Estética, Atención especial al prever una posible asistencia o fácil reparación por el cliente final. El sistema de inclinación diseñado independientemente del de apertura y cierre, hace que éste modelo sea la mejor solución presente en el mercado.

NL

Nieuw systeem voor het openen en sluiten van de zwevende parasol, zonder uw tuinmeubilair daarvoor te moeten verplaatsen. De parasol hoeft nu niet meer verwijderd te worden als u deze niet gebruikt, maar wordt bevestigd aan de mast. Dus geen storende parasol en parasolarm meer boven uw tuinmeubilair als de parasol niet als zodanig gebruikt wordt. Dit unieke systeem is door Scolaro ontwikkeld, waarbij extra aandacht besteed is aan belangrijke punten zoals: Functionaliteit, Vormgeving, Aan het mogelijk vervangen van onderdelen door de consument is extra aandacht besteed. Enige in zijn soort op de parasolmarkt dankzij het onafhankelijke open- en sluitsysteem.

-  -
-  300x300 | 350x350
-  300x400

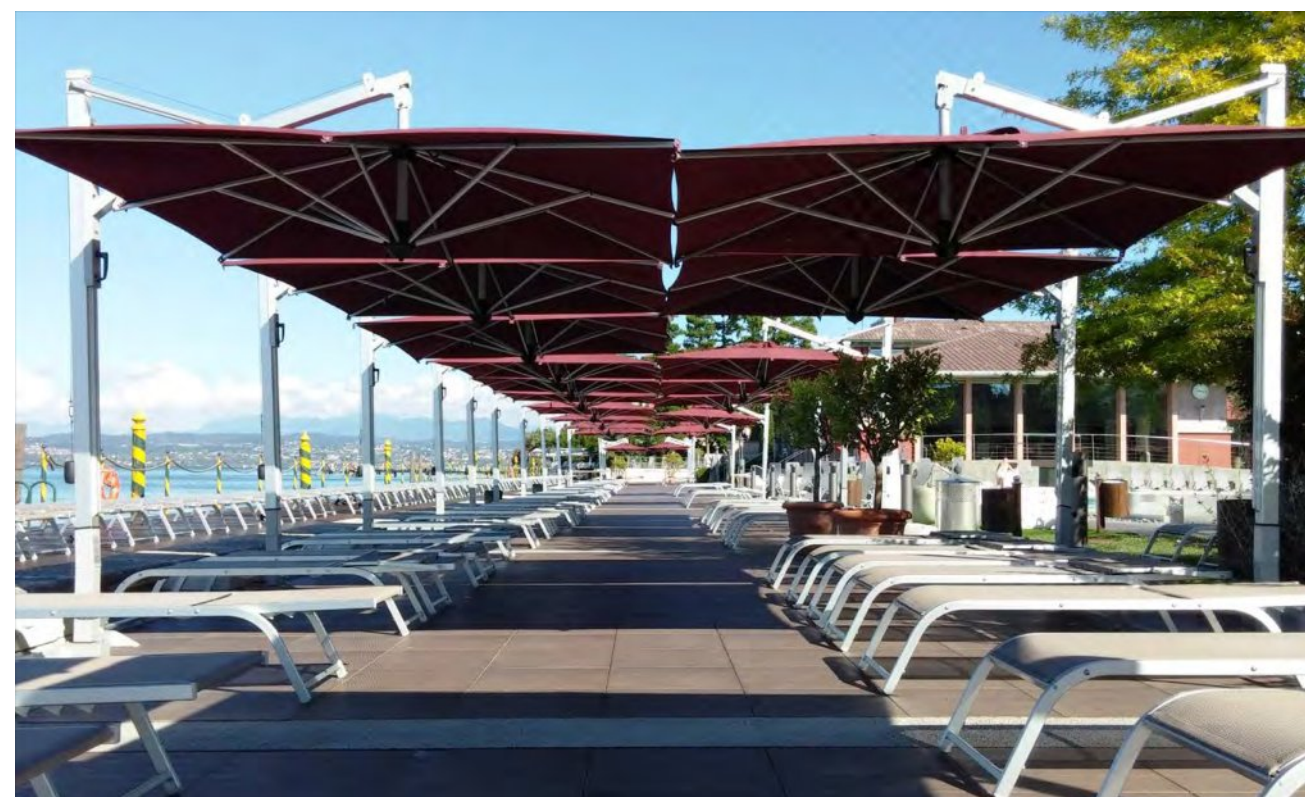



GALILEO STARWHITE

Il modello Galileo Retrattile, già molto apprezzato per gli accorgimenti tecnici e per la praticità di utilizzo, è disponibile anche con il telaio verniciato a polveri in colore Starwhite opaco. Questa variante rende il Galileo Starwhite ancora più elegante e sofisticato.

EN

The model Galileo Retractable, much appreciated for the technical and practical use, is also available with the frame powder coated in Starwhite matt. This variant makes the Galileo Starwhite even more elegant and sophisticated.





DE

Das einziehbare Modell Galileo, bisher insbesondere fuer den technischen und praktischen Einsatz geschätzt, ist auch mit pulverbeschichtetem Gestell in Farbe weiß Starwhite matt erhältlich. Diese Variante macht Galileo Starwhite noch eleganter und raffi nierter.

FR

Le modèle rétractable Galileo, très apprécié pour l'utilisation technique et pratique, est disponible aussi avec l'armature vernis en couleur Starwhite. Cette variante rend le Galileo Starwhite encore plus élégant et sophistiqué.

ES

El modelo galileo retrattile, es muy apreciado por los datos tecnicos y por ser muy practico en su uso, y tambien esta disponible con la estructura recubierta con pintura en polvo en color blanco. Esta variante hace al Galileo Starwhite aun mas elegante y sofi sticado.

NL

Het model Galileo Retrattile, befaamd vanwege het technische en praktische gebruiksgemak, is ook verkrijgbaar in Starwhite geëpoxeerde uitvoering. De uitvoering Galileo Starwhite is daardoor nog eleganter en chiquer.



-



300x300 | 350x350



300x400



GALILEO WOOD

Il modello Galileo Retrattile, già molto apprezzato per gli accorgimenti tecnici e per la praticità di utilizzo, si rinnova con l'introduzione della finitura effetto legno, completando la proposta per un pubblico raffinato ed attento alle tendenze del momento.

EN

The retractable Galileo, already highly appreciated for its technical features and practicality of use, is renewed with the introduction of the wood-effect finish, completing the offer for a refined and trend-conscious public.





DE

Das einziehbare Model Galileo ist dank seiner technischen Eigenschaften und praktischer Handhabung sehr geschätzt. Diese Serie wird nun mit der Einfuehrung der Holzoptik erneuert und vervollstaendigt das Angebot fuer ein anspruchsvolles und trendbewusstes Publikum

FR

Le modèle Galileo Rétractable, déjà très apprécié pour ses caractéristiques techniques et sa praticité d'utilisation, se renouvelle avec l'introduction de la finition effet bois, complétant la proposition destinée à un public raffiné et attentif aux tendances actuelles.

ES

El modelo retráctil Galileo, ya muy apreciado por sus características técnicas y practicidad de uso, se renueva con la introducción del acabado efecto madera, completando la propuesta para un público refinado y atento a las tendencias del momento.

NL

Het model Galileo Retractable, dat al zeer gewaardeerd werd om zijn technische kenmerken en gebruiksgemak, is vernieuwd met de introductie van de hout-look, wat het model verfijnd en trendy maakt. Retractable parasols sluiten tegen de mast, dus zijn zeer compact als ze gesloten zijn.



-



300x300 | 350x350



300x400



IT

Telaio disponibile in 3 varianti: Dark grigio antracite – Starwhite – Alu Wood. Ombrellone a braccio laterale con sistema di apertura e chiusura retrattile. Telaio in alluminio verniciato a polveri epossidiche. Accessori in nylon.

EN

Frame available in 3 variants: Dark anthracite – Starwhite – Alu Wood. Cantilever parasol with retractable opening and closing system. Aluminium frame epoxy coated. Accessories in nylon.

DE

Gestell in 3 Varianten erhältlich: Dark Anthrazitgrau – Starwhite – Alu Wood. Seitenarmschirm mit einziehbarem Öffnungs- und Schließungssystem. Gestell aus pulverbeschichtetem Aluminium. Zubehör aus Nylon.

FR

Armature disponible en 3 variantes: Gris anthracite – Starwhite – Alu Wood. Parasol bras déporté avec système rétractile. Armature en aluminium vernis. Accessoires en nylon.

ES

Estructura disponible en 3 opciones: Dark Antracita – Starwhite – Alu Wood. Parasol con palo lateral, sistema de apertura y cierre retráctil. Estructura de aluminio pintado con polvo epoxi. Accesorios en Nylon.

NL

Frame leverbaar in 3 kleuren: antraciet – Starwhite – Alu Wood. Vrijhangende parasol met intrekbaar openings- en sluitingssysteem. Frame van gepoedercoat aluminium. Onderdelen van nylon.



CHARACTERISTICS

			KG	M ³				
3,0x3,0	DARK C3030 GDR		65	0,45	82x82	8	18x30	
	STARWHITE C3030 GWR							
	WOOD C3030 GLR							
3,5 x 3,5	DARK C3535 GDR		75	0,45	82x82	8	18x30	
	STARWHITE C3535 GWR							
	WOOD C3535 GLR							
3,0 x 4,0	DARK C3040 GDR		75	0,45	82x82	8	18x30	
	STARWHITE C3040 GWR							
	WOOD C3040 GLR							

FINISHING



- Camino antivento
Wind cap



- Alu Dark
- Alu Starwhite
- Alu Wood



- Con meccanismo manovella
With winding mechanism



- Stecca con sistema "easy change"
Ribs with "easy change" system



- Alu Dark
- Alu Starwhite
- Alu Wood



- Inclinazione fino a 60°
Inclination up to 60°



- Sistema retrattile
Retractile system

INOX

- Viteria in inox
Screws in Stainless steel



- Ombrellone girevole a 360°
360-degree rotating umbrella

OPTIONAL

		BASES p. 186	BALLAST p. 194	GROUND FIXING p. 195	
3,0x3,0	DARK C3030 GDR	B1DS	PL1DS	BUD8080DS	
	STARWHITE C3030 GWR	B1BS	PL1BS	BUD8080BS	
	WOOD C3030 GLR	B1DS	PL1DS	BUD8080DS	
3,5 x 3,5	DARK C3535 GDR	B1DS	PL1DS	BUD8080DS	
	STARWHITE C3535 GWR	B1BS	PL1BS	BUD8080BS	
	WOOD C3535 GLR	B1DS	PL1DS	BUD8080DS	
3,0 x 4,0	DARK C3040 GDR	B1DS	PL1DS	BUD8080DS	
	STARWHITE C3040 GWR	B1BS	PL1BS	BUD8080BS	
	WOOD C3040 GLR	B1DS	PL1DS	BUD8080DS	

Base non compresa nel prezzo | Base not included in the price

COLOUR RANGE - p.204

ACRILYC 350GR

Con volante / with volant



A1S

ALL OPTIONS



T2S T3S

ALL OPTIONS

Senza volant / without volant



A1N

ALL OPTIONS



T6N T7N

ALL OPTIONS



T8N T9N S1N



GALILEO MAXI DARK

Ombrellone a braccio laterale con il sistema di chiusura retrattile misura 4x4 mt con la struttura ulteriormente irrobustita.

EN

Cantilever parasol with retractable closing system size 4x4 mt with a further strengthened structure.





DE

Seitenarmschirm mit einziehbarem Schliessungssystem in Grösse 4x4 m, Starkes Gestell.

FR

Parasol à bras latéral avec système de fermeture rétractable format 4x4 mt avec la structure renforcée.

ES

Parasol de brazo lateral y con sistema de cierre ó plegado retráctil 4x4 mts, estructura aún más reforzada.

NL

Zwevende parasol, die sluit aan de mast, 4x4 mtr. in een verzwaarde uitvoering.

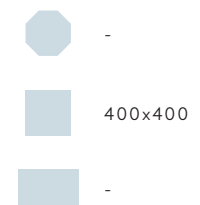

-

400x400

-



GALILEO MAXI STARWHITE

Ombrellone a braccio laterale con il sistema di chiusura retrattile è disponibile nella misura 4x4 mt con la struttura ulteriormente irrobustita, è disponibile con telaio verniciato a polveri epossidiche in colore Starwhite opaco.

EN

Cantilever parasol with retractable closing system is available in size 4x4 mt with a further strengthened structure, is available with frame epoxy coated color Starwhite matt.





DE

Seitenarmschirm mit einziehbarem Schliessungssystem ist in Grösse 4x4 m erhältlich, mit verstärkter Struktur, ist mit pulverbeschichtetem Gestell in Farbe Starwhite matt erhältlich.

FR

Parasol à bras latéral avec système de fermeture rétractable est disponible en format 4x4 mt avec la structure renforcée.

ES

Parasol de brazo lateral y con sistema de cierre ó plegado retráctil. Disponible en el tamaño de 4 x 4 mts, y con la estructura aún más reforzada, disponible con estructura pintada con polvo epoxi de color Starwhite mate.

NL

Zwevende parasol, die sluit aan de mast, is leverbaar in de afmeting 4 x 4 mtr. in een verzwaarde uitvoering, is leverbaar met gepoedercoat frame in Starwhite.

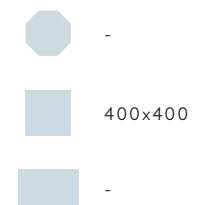



150

IT

Ombrellone a braccio laterale con sistema di apertura e chiusura retrattile. Telaio: Alluminio e componenti in acciaio; verniciato a polveri colore antracite o bianco. Accessori in nylon e meccanismo irrobustito.

EN

Cantilever parasol with retractable opening and closing. Frame: powder coated aluminium anthracite grey or white. Nylon accessories and strengthened mechanism.

DE

Pendelschirm mit einziehbarem Öffnungssystem. Gestell: Pulverbeschichtetes Aluminium Farbe Anthrazitgrau oder weiss. Nylonzubehoer und verstaerkter Mechanismus.

FR

Parasol bras deporté avec système retractile. Armature: Aluminium vernis couleur gris anthracite ou blanc. Accessoires en nylon et mécanisme renforcé.

ES

Parasol de brazo lateral con sistema con la apertura y cierre retráctil. Herraje: Aluminio y acero, recubierto con polvo de antracita o blanca. Accesorios de nailon y mecanismo reforzado

NL

Vrijhangende parasol. Frame: grijs of wit geëpoxeerd aluminium en staal. Nylon accessoires en versterkt mechanisme.



151

CHARACTERISTICS

4x4		110	0,55	92x92	8	18x35
	<p>DARK C4040 GDR</p> <p>STARWHITE C4040 GWR</p>					



OPTIONAL

4x4	<p>DARK C4040 GDR</p> <p>STARWHITE C4040 GWR</p>				
		PL1DS	PL1BS	BTAZS	CP3030ZS CP6565ZS

BASES p. 186 BALLAST p. 194 GROUND FIXING p. 195

Base non compresa nel prezzo | Base not included in the price

152 FINISHING

- Camino antivento
Wind cap
- Ombrellone girevole a 360°
360-degree rotating umbrella
- Viteria in inox
Screws in Stainless steel
- Stecca con sistema "easy change"
Ribs with "easy change" system
- Alu Dark
Alu Starwhite
- Con meccanismo manovella
With winding mechanism
- Sistema retrattile
Retractile system
- Alu Dark
Alu Starwhite
- Inclinazione fino a 60°
Inclination up to 60°

COLOUR RANGE - p.204

ACRILYC 350GR

- | | |
|----------------------------------------------------------------|--------------------------------------------------------------------|
| <p>Con volante / with volant</p> <p>A1S</p> <p>ALL OPTIONS</p> | <p>Senza volant / without volant</p> <p>A1N</p> <p>ALL OPTIONS</p> |
| <p>T2S T3S</p> <p>ALL OPTIONS</p> | <p>T6N T7N</p> <p>ALL OPTIONS</p> |
| | <p>T8N T9N S1N</p> |

VERIFICA LA STABILITÀ - p.196

Check stability - Vérifiez la stabilité - Stabilität prüfen - Compruebe la estabilidad - Controleer de stabiliteit



CAPRI DARK

La linea Capri presenta l'ombrellone in alluminio progettato per coprire grandi superfici con il minimo ingombro. La robustezza dei materiali e dei componenti e il sistema di apertura telescopico lo rende di facile utilizzo e ideale per un uso professionale.

EN

The aluminium range Capri is projected to cover big surfaces taking the minimum space. The strength of the materials and components and the telescopic opening system allow an easy and professional employ.





DE

Die Version Capri aus Aluminium ist fuer grosse Flaechen geeignet. Die Staerke der Materialien und der Bestandteile und das teleskopische Oeffnungssystem eignen sich insbesondere fuer einen gewerblichen Einsatz.

FR

La ligne Capri en aluminium est étudiée pour couvrir de grandes surfaces avec un encombrement minimum. La robustesse des matériaux et des composants, l'ouverture telescopique rendent ce parasol apte pour un emploi facile et professionnel.

ES

La línea CAPRI en aluminio esta concebido para cubrir grandes superficies ocupando el mínimo espacio. La resistencia de los materiales y de sus componentes, además de un moderno sistema de abertura telescópica, permite a este parasol, tener una utilización sencilla y profesional.

NL

CAPRI: een parasol met een aluminium frame en bij uitstek geschikt voor het overkappen van grotere terrassen. De teleskoop uitvoering maakt deze parasol ook zeer geschikt voor professioneel gebruik.



-



400x400 | 500x500 | 600x600



300x400 | 400x500 | 500x600



CAPRI STARWHITE

Versione del modello Capri ora disponibile con telaio verniciato a polveri epossidiche colore Starwhite, che rende questo ombrellone elegante e raffinato. La robustezza dei materiali e dei componenti e il sistema di apertura telescopico lo rende di facile utilizzo e ideale per un uso professionale.

EN

Version of the model Capri now available with aluminium frame epoxy coated color Starwhite, that makes the parasol elegant. The strength of the materials and components and the telescopic opening system allow an easy and professional employ.





DE

Version nun mit Aluminiumgestell pulverbeschichtet Farbe Starwhite , die diesem Schirm eine elegante Note verleiht. Die Staerke der Materialien und der Bestandteile und das teleskopische Oeffnungssystem eignen sich insbesondere fuer einen gewerblichen Einsatz.

FR

Version du modèle Capri avec une armature vernis Starwhite , qui rend ce parasol élégant et raffiné. La robustesse des matériaux et des composants, l'ouverture telescopique rendent ce parasol apte pour un emploi facile et professionnel.

ES

Versión del Parasol Capri, ahora disponible con estructura de aluminio pintada con polvo epoxi de color Starwhite, que le aporta elegancia y refinamiento. La resistencia de los materiales y de sus componentes, además de un moderno sistema de abertura telescópica, permite a este parasol, tener una utilización sencilla y profesional.

NL

Versie nu met gepoedercoat aluminium frame in de kleur Starwhite die de parasol een elegante uitstraling geeft. De teleskoop uitvoering maakt deze parasol ook zeer geschikt voor professioneel gebruik.



-



400x400 | 500x500 | 600x600



300x400 | 400x500 | 500x600



IT

Ombrellone gigante. Telaio con sistema di apertura telescopico in alluminio, componenti in acciaio verniciato a polveri colore antracite o bianca.

EN

Giant parasol. Telescopic opening system. Frame: powder coated aluminium, steel components anthracite grey or white.

DE

Riesenschirm. Teleskopoeffnungssystem Gestell: Pulverbeschichtetes Aluminium Farbe Anthrazitgrau oder weiss, Bestandteile aus Stahl.

FR

Parasol géant. Ouverture telescopique. Armature: Aluminium, composants en acier vernis couleur gris anthracite ou blanc.

ES

Parasol gigante con sistema de apertura telescópica. Herrajes: aluminio, componentes en acero color gris antracita o blanco.

NL

Maxi parasol: Telescoop systeem, voor het openen en sluiten van de parasol boven de tafel. Mast en baleinen: Grijs of wit geëpoxeerd aluminium en staal.



CHARACTERISTICS



4,0 x 4,0	DARK C4040 CAT			85	0,70	100	8	20x40
	STARWHITE C4040 CAW							
5,0 x 5,0	DARK C5050 CAT			130	0,80	100	8	20x40
	STARWHITE C5050CAW							
6,0 x 6,0	DARK C6060 CAT			150	0,90	100	8	20x40
	STARWHITE C6060 CAW							
3,0 x 4,0	DARK C3040 CAT			75	0,65	100	8	20x40
	STARWHITE C3040 CAW							
4,0 x 5,0	DARK C4050 CAT			120	0,80	100	8	20x40
	STARWHITE C4050 CAW							
5,0 x 6,0	DARK C5060CAT			140	0,90	100	8	20x40
	STARWHITE C5060 CAW							

FINISHING



- Camino antivento
Wind cap



- Sistema telescopico
Telescopic system



- Alu Dark
- Alu Starwhite



- Stecca con sistema "easy change"
Ribs with "easy change" system



- Alu Dark
- Alu Starwhite



- Viteria in inox
Screws in Stainless steel

BASES p. 186

BALLAST p. 194

GROUND FIXING p. 195



OPTIONAL

4,0 x 4,0	DARK C4040 CAT	PL1DS	BUD8080DS	◆	BTAZS	CP6565ZS
	STARWHITE C4040 CAW	PL1BS	BUD8080BS			
5,0 x 5,0	DARK C5050 CAT	PL1DS	/	◆	BTAZS	CP6565ZS
	STARWHITE C5050CAW	PL1BS	/			
6,0 x 6,0	DARK C6060 CAT	PL1DS	/	◆	BTAZS	CP6565ZS
	STARWHITE C6060 CAW	PL1BS	/			
3,0 x 4,0	DARK C3040 CAT	PL1DS	BUD8080DS	◆	BTAZS	CP6565ZS
	STARWHITE C3040 CAW	PL1BS	BUD8080BS			
4,0 x 5,0	DARK C4050 CAT	PL1DS	/	◆	BTAZS	CP6565ZS
	STARWHITE C4050 CAW	PL1BS	/			
5,0 x 6,0	DARK C5060CAT	PL1DS	/	◆	BTAZS	CP6565ZS
	STARWHITE C5060 CAW	PL1BS	/			

Base non compresa nel prezzo | Base not included in the price

COLOUR RANGE - p.204

ACRILYC 350GR

Con volante / with volant



A1S

ALL OPTIONS

Senza volant / without volant



A1N

ALL OPTIONS



T2S T3S

ALL OPTIONS



T6N T7N

ALL OPTIONS



T8N T9N S1N

VERIFICA LA STABILITÀ - p.196

Check stability - Vérifiez la stabilité - Stabilität prüfen - Compruebe la estabilidad - Controleer de stabiliteit



ALU POKER / DOUBLE DARK

Struttura modulare in alluminio composta da 2 (Double) o 4 (Poker) ombrelloni ancorati ad un unico sostegno studiata per la copertura di ampie superfici con il minimo ingombro.

Versione con telaio colore grigio antracite.
Intramontabile e adatta per qualsiasi ambiente.

EN

Aluminium structure made of 2 (Double) or 4 (Poker) parasols fixed at the same pole, suitable for big surfaces and minimum encumbrance. Version with dark anthracite grey frame. Timeless and always suitable for any environment.





DE

Alugestell mit 2 (Double) oder 4 (Poker) Schirmen, die am selben Mast befestigt sind. Raumsparend und fuer grosse Flaechen geeignet. Version mit Aluminiumgestell in Farbe Anthrazitgrau. Zeitlos und fuer alle Anwendungen geeignet.

FR

Structure en aluminium avec 2 (Double) ou 4 (Poker) parasols fixés à un mat. Pour grandes surfaces avec encombrement minimum. Version avec armature gris anthracite. Intemporel et adapte à tout environnement.

ES

Estructura modular de aluminio compuesta por 2(doble) o 4 (poker) parasoles unidos por un solo mástil, muy adecuado para amplias superficies con poco espacio. Versión clásica siempre apreciada con soportes de aluminio con un acabado especial efecto Iroko y brazos superiores de madera maciza de Iroko.

NL

Parasolmast met 2 (Double) of 4 (Poker) parasols. Deze parasols (Double ca. 25 m² en Poker ca. 50 m²) zijn aan 1 mast bevestigd. Zijn daardoor ruimtebesparend en zeer geschikt voor grotere oppervlakten en terrassen. klassiek, al lange tijd zeer gewaardeerde uitvoering met aluminium mast in Iroko-houten print en met Iroko-houten baleinen.

 600x600 | 700x700

 300x600 | 350x700



ALU POKER / DOUBLE STARWHITE

Struttura modulare in alluminio composta da 2 (Double) o 4 (Poker) ombrelloni ancorati ad un unico sostegno studiata per la copertura di ampie superfici con il minimo ingombro. Ora disponibile con struttura interamente verniciata a polveri colore Starwhite.

EN

Aluminium structure made of 2 (Double) or 4 (Poker) parasols fixed at the same pole, suitable for big surfaces and minimum encumbrance. Now available with the entire frame epoxy coated color Starwhite.



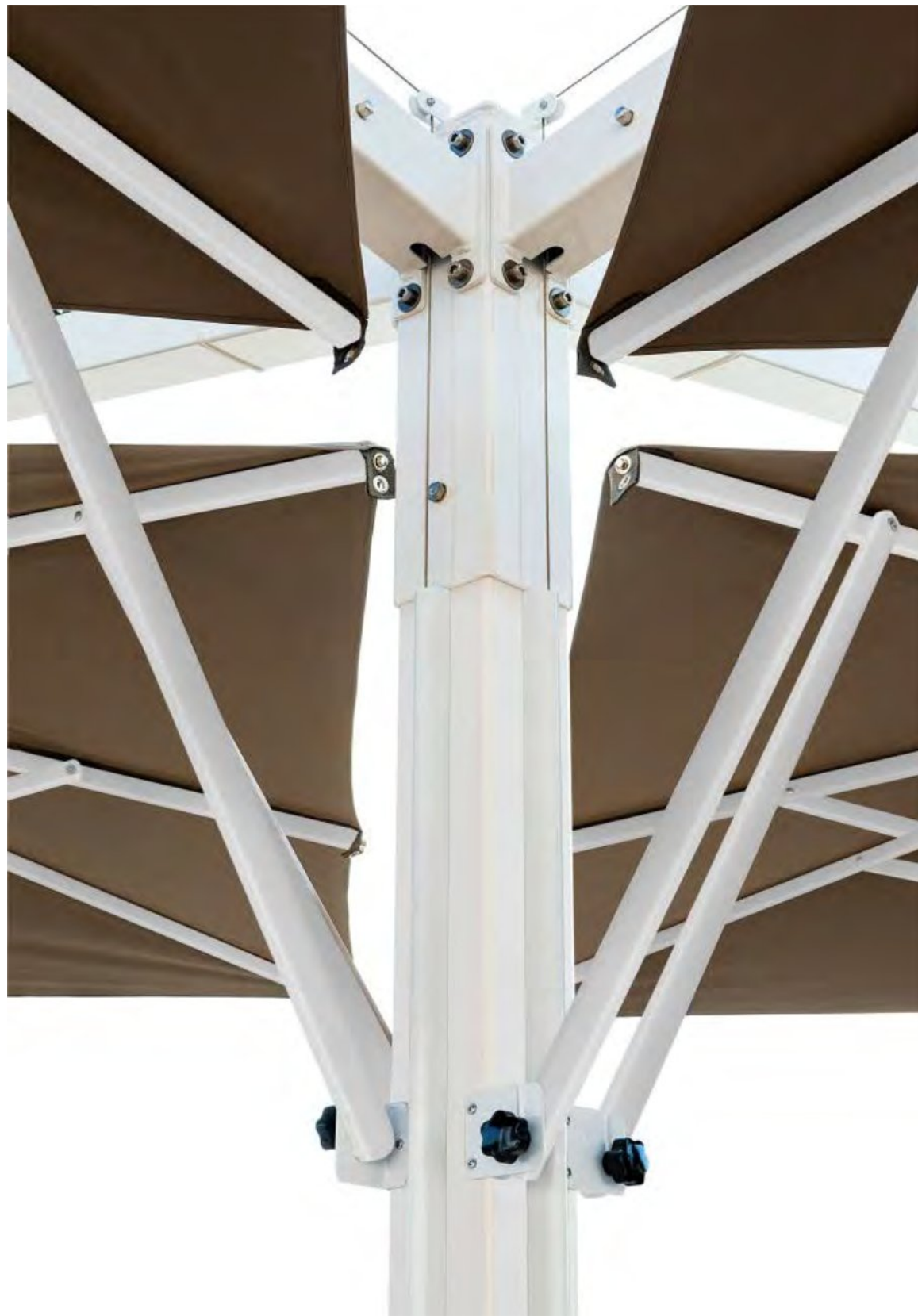

DE

Alugestell mit 2 (Double) oder 4 (Poker) Schirmen, die am selben Mast befestigt sind. Raumsparend und fuer grosse Flaechen geeignet. Nun mit Aluminiumgestell pulverbeschichtet Farbe Starwhite erhaeltlich.

FR

Structure en aluminium avec 2 (Double) ou 4 (Poker) parasols fixés à un mat. Pour grandes surfaces avec encombrement minimum. Maintenant disponible avec une structure de couleur Starwhite.

ES

Estructura modular de aluminio compuesta por 2(doble) o 4 (poker) parasoles unidos por un solo mástil, muy adecuado para amplias superficies con poco espacio. Ahora disponible con la estructura totalmente pintada con polvo epoxi de color Starwhite.

NL

Parasolmast met 2 (Double) of 4 (Poker) parasols. Deze parasols (Double ca. 25 m² en Poker ca. 50 m²) zijn aan 1 mast bevestigd. Zijn daardoor ruimtebesparend en ze er geschikt voor grotere oppervlakten en terrassen. Nu leverbaar met gepoedercoat aluminium frame in Starwhite.

 600x600 | 700x700

 300x600 | 350x700



WOOD POKER / DOUBLE

Struttura modulabile in legno composta da 2 (Double) o 4 (Poker) ombrelloni ancorati ad un unico sostegno studiata per la copertura di ampie superfici con il minimo ingombro. Disponibile con nuovo sostegno verticale in alluminio con speciale finitura effetto Iroko e stecche in legno Iroko.

EN

Wooden structure made of 2 (Double) or 4 (Poker) parasols fixed at the same pole, suitable for big surfaces and minimum encumbrance. Available with new vertical aluminium post with special Iroko wood finishing and ribs made of Iroko wood.





DE

Holzstruktur mit 2 (Double) oder 4 (Poker) Schirmen, die am selben Mast befestigt sind. Raumsparend und fuer grosse Flaechen geeignet. Mit Alumast mit Irokoholoptik und Streben aus Irokoholz erhaeltlich.

FR

Structure en bois avec 2 (Double) ou 4 (Poker) parasols fixés à un mat. Pour grandes surfaces avec encombrement minimum. Disponible avec nouvelle mat vertical en aluminium avec effet bois Iroko et baleines en bois Iroko.

ES

Estructura modular de madera compuesta por 2 (doble) o 4 (poker) parasoles unidos por un solo mástil, muy adecuado para amplias superficies con poco espacio. Disponible con nuevo soporte vertical en aluminio y con acabado especial en imitacion madera Iroko y varillas en madera Iroko.

NL

Parasolmast met 2 (Double) of 4 (Poker) parasols. Deze parasols (Double ca. 25 m² en Poker ca. 50 m²) zijn aan 1 mast bevestigd. Zijn daardoor ruimtebesparend en zeer geschikt voor grotere oppervlakten en terrassen. Verkrijgbaar met nieuwe aluminium mast met uniek Iroko uitstraling. Iroko houtten baleinen.

 600x600 | 700x700

 300x600 | 350x700



IT

Struttura robusta composta da 4 ombrelloni (Poker) oppure da 2 ombrelloni (Double). Telaio in alluminio e componenti in acciaio; verniciato a polveri colore antracite/bianco. Accessori in nylon e meccanismo irrobustito.

EN

Strong structure made of 4 cantilever parasols (Poker) or 2 cantilever parasols (Double). Frame in coated aluminium and steel components powder coated anthracite grey/white. Nylon accessories and strengthened mechanism.

DE

Starke Gestell mit 4 Pendelschirmen (Poker) oder 2 Pendelschirmen (Double) Gestell aus pulverbeschichtetem Aluminium und Bestandteile aus Stahl Farbe Anthrazitgrau/Weiß. Nylonzubehoer und verstaerkter Mechanismus.

FR

Structure robuste avec 4 parasols (Poker) ou 2 parasols (Double). Armature en aluminium vernis, composants en acier couleur gris anthracite/blanc. Accessoires en nylon et mécanisme renforcé.

ES

Estructura robusta que se compone de 4 parasoles (Poker) – 2 parasoles (Double). Herrajes: Aluminio y acero color gris antracita/blanco. Accesorios de nailon y mecanismo reforzado.

NL

Zware mast met 4 (Poker) – 2 (Double) vrijhangende parasols: Mast en baleinen: Grijs geëpoxideerd aluminium. Overige metalen delen: Grijs/Wit geëpoxideerd staal. Nylon accessoires en versterkt mechanisme.



CHARACTERISTICS



Size	Model	Weight (KG)	Volume (M³)	Dimensions	Accessories
6,0 x 6,0	C6060 APO			18x30	
	C6060 APW	170	1,00	120x120	18x30
	C6060 WPO			18x34	
7,0 x 7,0	C7070 APO			18x30	
	C7070 APW	185	1,00	120x120	18x30
	C7070 WPO			18x34	
3,0 x 6,0	C3060 APO			18x30	
	C3060 APW	100	0,80	120x120	18x30
	C3060 WPO			18x34	
3,5 x 7,0	C3570 APO			18x30	
	C3570 APW	110	0,80	120x120	18x30
	C3570 WPO			18x34	

FINISHING



• Camino antivento
Wind cap



• Con meccanismo manovella
With winding mechanism



• Alu Dark
• Alu Starwhite
• Iroko Wood



• Stecca con sistema "easy change"
Ribs with "easy change" system



• Alu Dark
• Alu Starwhite
• Alu Iroko



INOX • Viteria in inox
Screws in Stainless steel



• Blocco antivento
Wind stop

OPTIONAL



Size	Model	Accessories	Ground Fixing
6,0 x 6,0	C6060 APO		
	C6060 APW	◆ ◆	BTBS CP6565ZS
	C6060 WPO		
7,0 x 7,0	C7070 APO		
	C7070 APW	◆ ◆	BTBS CP6565ZS
	C7070 WPO		
3,0 x 6,0	C3060 APO		
	C3060 APW	◆ ◆	BTBS CP6565ZS
	C3060 WPO		
3,5 x 7,0	C3570 APO		
	C3570 APW	◆ ◆	BTBS CP6565ZS
	C3570 WPO		

Base non compresa nel prezzo | Base not included in the price

COLOUR RANGE - p.204

ACRILYC 350GR

Con volante / with volant



A1S

ALL OPTIONS

Senza volant / without volant



A1N

ALL OPTIONS



T2S

T3S

ALL OPTIONS



T6N

T7N

ALL OPTIONS



T8N

T9N

S1N

VERIFICA LA STABILITÀ - p.196

Check stability - Vérifiez la stabilité - Stabilität prüfen - Compruebe la estabilidad - Controleer de stabiliteit

ROMEO NEW

Forma e design essenziale: una proposta ideata per le esigenze della ristorazione. Linee regolari ma eleganti con la massima versatilità per valorizzare spazi prima inutilizzati. Struttura in acciaio zincato e verniciato, adatto per tutte le stagioni. Con calamita per un facile e veloce accoppiamento.



EN

Essential shape and design: a proposal developed for the demands of the HORECA sector. Regular yet elegant lines with maximum versatility to enhance unused spaces. Galvanized and painted steel frame, suitable for all seasons. With magnet for quick and easy coupling. Available in dark and Starwhite finish.



DE

Minimale Form und Design: geeignet fuer den Gastronomiebedarf. Regelmässige, aber elegante Linien mit maximaler Vielseitigkeit, um bisher ungenutzte Raeume aufzuwerten. Struktur aus verzinktem und lackiertem Stahl, fuer alle Jahreszeiten geeignet. Mit Magnet fuer ein schnelles und einfaches Zusammenstellen.

FR

Forme et design essentiels : une proposition conçue pour les besoins de la restauration. Des lignes régulières mais élégantes avec une polyvalence maximale pour mettre en valeur des espaces auparavant inutilisés. Structure en acier galvanisé et vernis, adaptée à toutes les saisons. Avec aimant pour un appairage rapide et facile. Disponible en finitions Anthracite et Starwhite.

ES

Forma y design esenciales: una propuesta pensada para las necesidades de restauración. Líneas regulares pero elegantes con la máxima versatilidad para realzar espacios no utilizados anteriormente. Estructura de acero galvanizado y pintado, apta para todas las estaciones. Con imán para un emparejamiento rápido y sencillo. Disponible en acabado Antracita y Starwhite.

NL

Minimalistisch design: een tafel ontworpen voor de behoeften vanuit de horeca. Strakke, elegante lijnen met maximale veelzijdigheid om de capaciteit onder de parasol te verbeteren. Gegalvaniseerde en gelakte stalen structuur, geschikt voor alle seizoenen. Met magneet voor snelle en eenvoudige koppeling.

CHARACTERISTIC

	↑	KG
DARK T75D	1200 x 600 x 750	38 Kg
STARWHITE T75W		

COLOUR RANGE

- Antracite
Dark
- Bianco
Starwhite

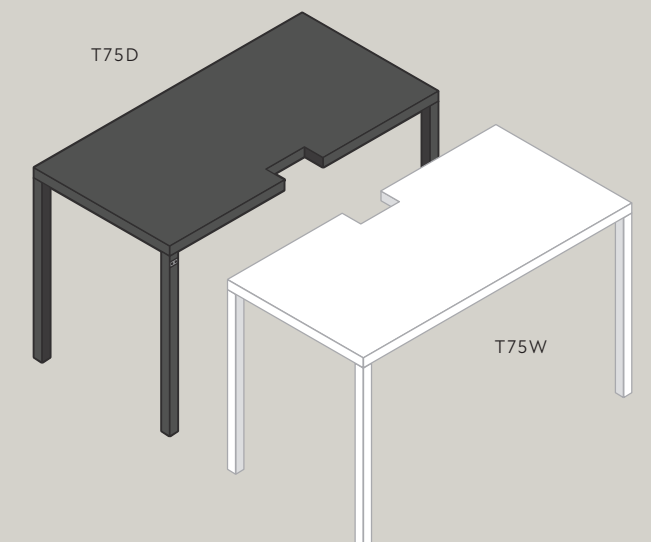

GIULIETTA **NEW**

Pratica e robusta, un contributo per tutti i dehor. Sfrutta l'area di ingombro della base trasformandola in un'ulteriore zona di seduta e rendendo l'ombrellone utilizzabile per tutta la sua superficie. Struttura in acciaio zincato e verniciato. Con calamita per un facile e veloce accoppiamento.



EN
Practical and sturdy, a useful contribution to all patios. Capitalizes the footprint area of the base by transforming it into an additional seating area and making the umbrella operable for its entire surface area. Galvanized and painted steel frame, suitable for all seasons. With magnet for quick and easy coupling. Available in dark and starwhite finish.

DE
Vielseitig und stark, geeignet fuer alle Aussenbereiche. Die Flaeche des Staenders wird genutzt und in eine zusaetzliche Sitzflaeche verwandelt. Somit ist der Schirm auf seiner gesamten Flaeche nutzbar. Gestell aus verzinktem und lackiertem Stahl. Mit Magnet fuer ein schnelles und einfaches Zusammenstellen.

FR
Pratique et robuste, un apport pour tous les espaces extérieurs. Profitez de la surface encombrante de la base en la transformant en un coin salon supplémentaire et en rendant le parasol utilisable sur toute sa surface. Structure en acier galvanisé et vernis. Avec aimant pour un appairage rapide et facile. Disponible en finitions Anthracite et Starwhite.

ES
Práctico y robusto, un aporte para todos los espacios exteriores. Aprovecha la voluminosa zona de la base transformándola en una zona de asiento adicional y haciendo que la sombrilla sea utilizable en toda su superficie. Estructura de acero galvanizado y pintado. Con imán para un emparejamiento rápido y sencillo. Disponible en acabado Antracita y Starwhite.

NL
Praktisch en stevig, een aanwinst voor elk terras. Het maakt gebruik van de parasolvoet door er een extra zitplek van te maken en de parasol te benutten over het hele oppervlak. Gegalvaniseerd en gelakt stalen structuur. Met magneet voor snelle en eenvoudige koppeling.

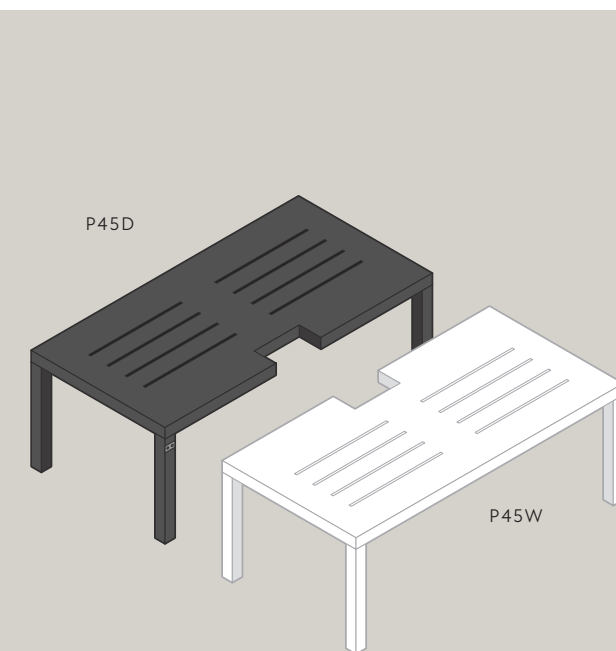

CHARACTERISTIC

		↑	↓
		KG	
DARK P45D	1200 x 600 x 450	18 Kg	
STARWHITE P45W			

COLOUR RANGE

- Antracite Dark
- Bianco Starwhite

BASES STANDARD / TELESCOPIC

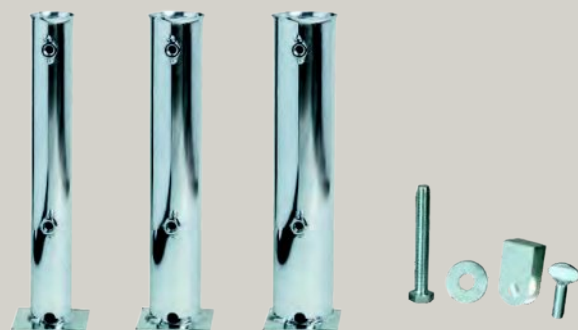

BT45 - BT55 - BT65

- Tubo in acciaio zincato. Doppio galletto. Viteria inclusa.
- Steel zinced tube. Double wing nut. Screws included.
- Verzinkte Stahlhülse. Doppelte Hutmutter. Schrauben inbegriffen.
- Tube acier zingué. Avec écrou papillon. Visserie incl.
- Tubo de acero galvanizado. Los tornillos incluidos.
- Koker gegalvaniseerd. Inclusief schroeven.

				KG
BT45	42 mm	45 mm	36-40 mm	1 Kg
BT55	52 mm	55 mm	47-50 mm	
BT65	62 mm	65 mm	55-60 mm	

BTT45 - BTT55 - BTT65

- Tubo acciaio per fissaggio a terra. Eventualmente da abbinare all'articolo BTC.
- Steel tube for ground fixing. Possibility to combine it with Art BTC.
- Stahlhülse fuer Bodenbefestigung. Eventuell mit Art BTC kombinierbar.
- Tube en acier pour fixation au sol. Eventuellement à joindre avec BTC.
- Tubo de acero para sujeción al suelo. Posiblemente para que coincida con el artículo BTC.
- Metalen koker voor betonanker. Te gebruiken in combinatie met artikel BTC.

				KG
BTT45	42 mm	45 mm	36-40 mm	1 Kg
BTT55	52 mm	55 mm	47-50 mm	
BTT65	62 mm	65 mm	55-60 mm	

BTC

- Supporto da interrare. Da abbinare a BTT55 e BTT65.
- supporta for ground fixing. To combine with BTT55 and BTT65.
- Staender zum einbetonieren. Kombinierbar mit BTT55 und BTT65.
- Pied pour fixation au sol. A joindre avec BTT55 et BTT65.
- Pie para fijar al suelo. Combinar con BTT55 y BTT65.
- Betonanker, te gebruiken in combinatie met BTT55 en BTT65.

		KG
BTC	47-50 mm	1,3 Kg



BF6565D - BF6666D

- Base in acciaio colore antracite. Tubo incl.
- Steel base colour antracite grey. Tube incl.
- Stahlstaender grau pulverbeschichtet. Hülse inbegriffen.
- Pied en acier vernis coul. gris. Tube incl.
- Pie de acero de color antracita. Tubo incluido.
- Parasolvoet grijs geëpoxeerde metaalplaat. Wordt geleverd met koker.

					KG
BF6565D/T45	650x650x15 mm	42 mm	45 mm	36-40 mm	35 Kg
BF6565D/T55		52 mm	55 mm	47-50 mm	
BF6565D/T65		62 mm	65 mm	55-60 mm	
BF6666D/T45	650x650x25 mm	42 mm	45 mm	36-40 mm	70 kg
BF6666D/T55		52 mm	55 mm	47-50 mm	
BF6666D/T65		62 mm	65 mm	55-60 mm	

BF6565W - BF6666W **NEW**

- Base in acciaio Starwhite. Tubo incl.
- Starwhite finish steel base. Tube included.
- Stahlstaender pulverbeschichtet Farbe weiss. Hülse inbegriffen.
- Pied en acier vernis Starwhite. Tube inclus.
- Base de acero pintado Starwhite. Tubo incluido.
- Parasolvoet metaal in witte kleur. Wordt geleverd met koker.



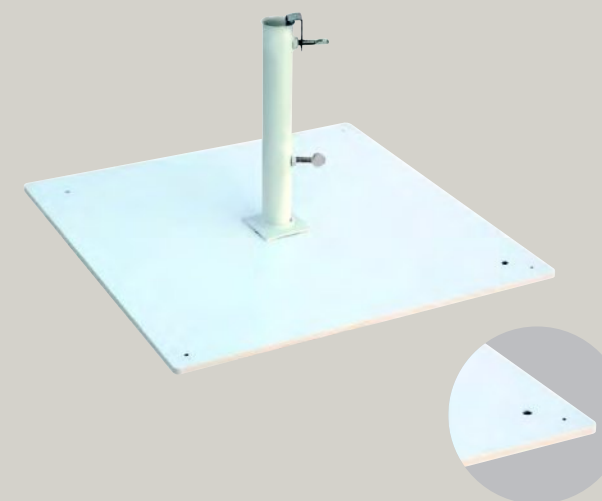

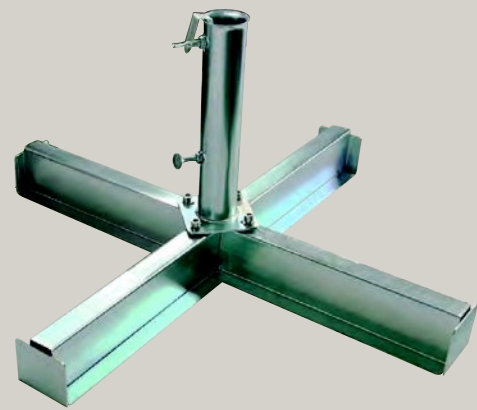
					KG
BF6565W/T45	650x650x15 mm	42 mm	45 mm	36-40 mm	35 Kg
BF6565W/T55		52 mm	55 mm	47-50 mm	
BF6565W/T65		62 mm	65 mm	55-60 mm	
BF6666W/T45	650x650x25 mm	42 mm	45 mm	36-40 mm	70 kg
BF6666W/T55		52 mm	55 mm	47-50 mm	
BF6666W/T65		62 mm	65 mm	55-60 mm	





BQ8080ZS



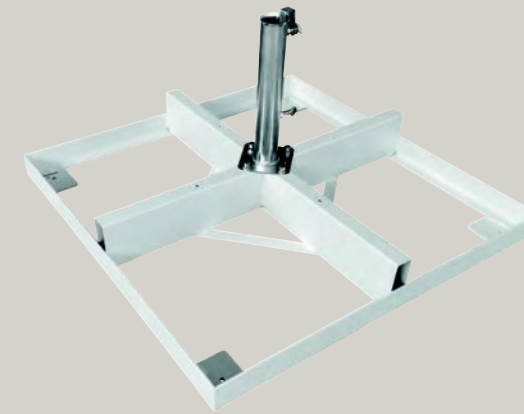

- Base a croce metallica zincata. Disponibile con BTT55 e BTT65. Tubo incluso. Da abbinare a 8 piastre cemento Art.BC4040
- Zinced cross metal base. Available with BTT55 and BTT65. Tube included. To combine with 8 cement plates Art.BC4040
- Verzinkte Stahlplattenstaender. Verfuegbar mit BTT55 und BTT65. Huelse inbegriffen. Zum kombinieren mit 8 Betonplatten Art.BC4040
- Pied en acier galvanisé. Disponible avec BTT55 et BTT65. Tube incl. À combiner avec 8 dalles ciment Art.BC4040
- Base de metal galvanizado. Disponible con BTT55 y BTT65. Tubo incluido. Para combinar con 8 placas de hormigón Art.BC4040
- Metalen basis, verzinkt. Verkrijgbaar met BTT55 en BTT65. Tube inbegrepen. Te combineren met 8 betonplaten Art.BC4040

					KG 
BQ8080ZS/T55	850x850 mm	52 mm	55 mm	47-50 mm	8 Kg
BQ8080ZS/T65		62 mm	65 mm	55-60 mm	



BUD8080BS



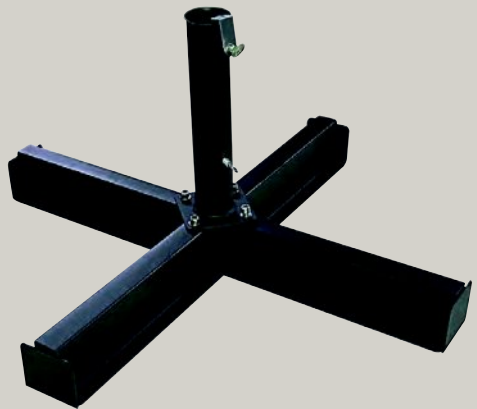

- Base a croce metallica colore bianco Starwhite. Disponibile con BTT55 e BTT65. Tubo incluso. Da abbinare a 12 piastre cemento Art.BC4040
- White cross metal base. Available with BTT55 and BTT65. Tube included. To combine with 12 cement plates Art.BC4040
- Weisser Stahlplattenstaender. Verfuegbar mit BTT55 und BTT65. Huelse inbegriffen. Zum kombinieren mit 12 Betonplatten Art.BC4040
- Pied en acier blanc. Disponible avec BTT55 et BTT65. Tube incl. À combiner avec 12 dalles ciment Art.BC4040
- Base de metal blanca. Disponible con BTT55 y BTT65. Tubo incluido. Para combinar con 12 placas de hormigón Art.BC4040
- Wit metalen basis. Verkrijgbaar met BTT55 en BTT65. Tube inbegrepen. Te combineren met 12 betonplaten Art.BC4040

					KG 
BUD8080BS/T55	850x850 mm	52 mm	55 mm	47-50 mm	32 Kg
BUD8080BS/T65		62 mm	65 mm	55-60 mm	



BQ8080DS



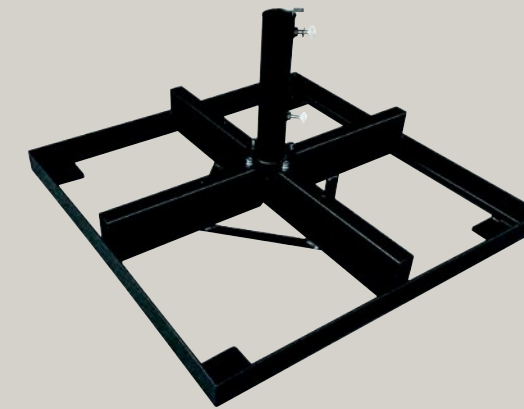

- Base a croce metallica colore antracite. Disponibile con BTT55 e BTT65. Tubo incluso. Da abbinare a 8 piastre cemento Art.BC4040
- Dark cross metal base. Available with BTT55 and BTT65. Tube included. To combine with 8 cement plates Art.BC4040
- Stahlplattenstaender. Anthrazitgrau. Verfuegbar mit BTT55 und BTT65. Huelse inbegriffen. Zum kombinieren mit 8 Betonplatten Art.BC4040
- Pied en acier gris. Disponible avec BTT55 et BTT65. Tube incl. À combiner avec 8 dalles ciment Art.BC4040
- Base de metal gris. Disponible con BTT55 y BTT65. Tubo incluido. Para combinar con 8 placas de hormigón Art.BC4040
- Metalen basis. Houtskoolgrijs. Verkrijgbaar met BTT55 en BTT65. Tube inbegrepen. Te combineren met 8 betonplaten Art.BC4040

					KG 
BQ8080DS/T55	850x850 mm	52 mm	55 mm	47-50 mm	8 Kg
BQ8080DS/T65		62 mm	65 mm	55-60 mm	



BUD8080DS

- Base a croce metallica colore antracite. Disponibile con BTT55 e BTT65. Tubo incluso. Da abbinare a 12 piastre cemento Art.BC4040
- Dark cross metal base. Available with BTT55 and BTT65. Tube included. To combine with 12 cement plates Art.BC4040
- Stahlplattenstaender anthrazitgrau. Verfuegbar mit BTT55 und BTT65. Huelse inbegriffen. Zum kombinieren mit 12 Betonplatten Art.BC4040
- Pied en acier gris. Disponible avec BTT55 et BTT65. Tube incl. À combiner avec 12 dalles ciment Art.BC4040
- Base de metal gris. Disponible con BTT55 y BTT65. Tubo incluido. Para combinar con 12 placas de hormigón Art.BC4040
- Metalen basis. Houtskoolgrijs. Verkrijgbaar met BTT55 en BTT65. Tube inbegrepen. Te combineren met 12 betonplaten Art.BC4040

					KG 
BUD8080DS/T55	850x850 mm	52 mm	55 mm	47-50 mm	32 Kg
BUD8080DS/T65		62 mm	65 mm	55-60 mm	

BC35MA4 NEW



- Base in cemento graniglia bianca con maniglie. Disponibile con tubo BTT45, BTT55, BTT65. Tubo incluso.
- White cement grit base with handles. Available with tube BTT45, BTT55, BTT65. Tube incl.
- Weisser Kiesbetonstaender mit Handgriffen. Verfuegbar mit Huelse BTT45, BTT55, BTT65. Huelse inbegr.
- Pied ciment grés blanc avec poignées. Disponible avec tube BTT45, BTT55, BTT65. Tube incl.
- Base de cemento y arena blanca con asas. Disponible con tubo BTT45, BTT55, BTT65. Tubo incluido.
- Wit parasolvoet gewassen grind met handgrepen. Inclusief koker, maat naar keuze: BTT45, BTT55, BTT65.

BC35MA4/T45		42 mm	45 mm	36-40 mm	
BC35MA4/T55	Ø 540 mm	52 mm	55 mm	47-50 mm	35 Kg
BC35MA4/T65		62 mm	65 mm	55-60 mm	

BC55MA4/BC80MA4



- Base in cemento graniglia bianca con maniglie. Disponibile con tubo BTT45, BTT55, BTT65. Tubo incluso.
- White cement grit base with handles. Available with tube BTT45, BTT55, BTT65. Tube incl.
- Weisser Kiesbetonstaender mit Handgriffen. Verfuegbar mit Huelse BTT45, BTT55, BTT65. Huelse inbegr.
- Pied ciment grés blanc avec poignées. Disponible avec tube BTT45, BTT55, BTT65. Tube incl.
- Base de cemento y arena blanca con asas. Disponible con tubo BTT45, BTT55, BTT65. Tubo incluido.
- Wit parasolvoet gewassen grind met handgrepen. Inclusief koker, maat naar keuze: BTT45, BTT55, BTT65.

BC55MA4/T45		42 mm	45 mm	36-40 mm	
BC55MA4/T55	Ø 600 mm	52 mm	55 mm	47-50 mm	55 Kg
BC55MA4/T65		62 mm	65 mm	55-60 mm	
BC80MA4/T45		42 mm	45 mm	36-40 mm	
BC80MA4/T55	Ø 640 mm	52 mm	55 mm	47-50 mm	80 Kg
BC80MA4/T65		62 mm	65 mm	55-60 mm	

BC5151GRA4



- Piastra in cemento grigio con maniglie. Disponibile con tubo BTT45, BTT55, BTT65. Tubo incluso.
- Concrete grey cement slab with handles. Available with tube BTT45, BTT55, BTT65. Tube incl.
- Grauer Betonplatte mit Handgriffen. Verfuegbar mit Huelse BTT45, BTT55, BTT65. Huelse inbegr.
- Dalles ciment couleur gris avec poignées. Disponible avec tube BTT45, BTT55, BTT65. Tube incl.
- Base de cemento gris con asas. Disponible con tubo BTT45, BTT55, BTT65. Tubo incluido.
- Betontegel grijs met handgrepen. Inclusief koker, maat naar keuze: BTT45, BTT55, BTT65.

BC5151GRA4/T45		42 mm	45 mm	36-40 mm	
BC5151GRA4/T55	500x500 mm	52 mm	55 mm	47-50 mm	60 Kg
BC5151GRA4/T65		62 mm	65 mm	55-60 mm	

OPTIONAL CROSS METAL BASES

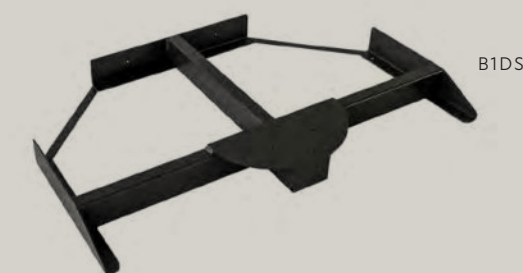

B1DS

B1DS - B1BS

- Base metallica opzionale per ombrelloni a braccio laterale.
- Optional metal base for side arm parasols.
- Optionaler Metallstaender fuer Ampelschirme.
- Base en métal en option pour parasols à bras déporté.
- Base de metal opcional para sombrillas de brazos laterales.
- Optionele metalen voet voor zijarmparaplu's.

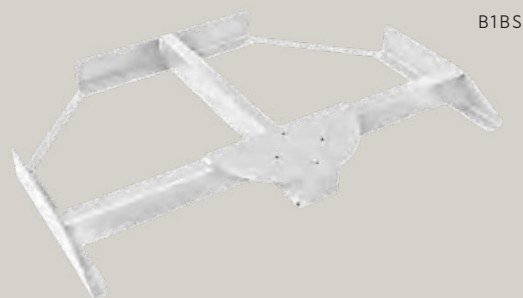

B1BS

B1DS		
B1BS	1070x710x85 mm	15 Kg

PL1DS - PL1BS

- Base a croce metallica opzionale per ombrelloni a braccio laterale.
- Optional cross metal base for side arm parasols.
- Optionaler Kreuz-Metallstaender fuer Ampelschirme.
- Base croix en métal en option pour parasols à bras déporté.
- Base cruz de metal opcional para sombrillas de brazos laterales.
- Optionele kruis metalen voet voor zijarmparaplu's.



PL1DS

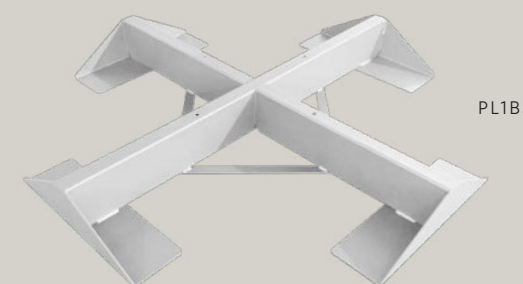

PL1BS

PL1DS		
PL1BS	1090x1090x130 mm	22 Kg

Pag. 194

Da completare:
To be completed / Ballast ergaenzen /
A compléter avec ballasts / Completar con losas /
Aan te vullen met voorschakelapparaten

con zavorre
 Available ballasts / Verfuegbarer Ballast /
 Ballasts disponibles / Losas disponibles /
 Beschikbare ballasten

Pag. 196

schema di stabilità
 see stability diagram / Stabilitaetsdiagramm /
 diagramme de stabilité / diagrama de estabilidad /
 stabiliteitsdiagram

BCCS - BCWS

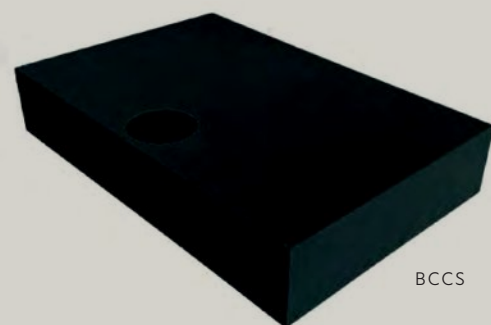

- Carter acciaio zincato e verniciato a polveri. Colori disponibili dark-Starwhite. Compatibile con base B1DS-B1BS.
- Zined and epoxy coated steel carter. Available colors dark-Starwhite. Compatible with base B1DS-B1BS.
- Verzinkter und pulverbeschichteter Stahlcarter. Erhaeltliche Farben dark-Starwhite. Kompatibel mit Staender B1DS-B1BS.
- Carter acier galvanise' et vernis. Couleurs disponibles dark-Starwhite. Compatible avec socle B1DS-B1BS.
- Carter de acero galvanizado y pintado. Colores disponibles dark-Starwhite. Compatible con base B1DS-B1BS.
- Gegalvaniseerd en geepoxeerde metaalcarter. Beschikbare kleuren dark-Starwhite. Compatibel met basis B1DS-B1BS.



BCCS



BCWS

		KG 
BCCS	1100x720x200 mm	18 Kg
BCWS		

BDCS - BDWS

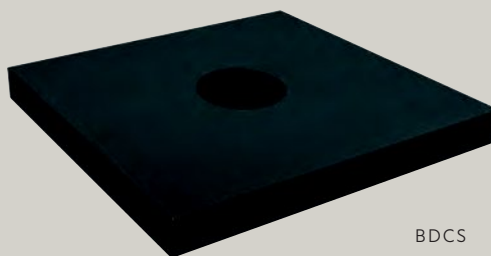

- Carter acciaio zincato e verniciato a polveri. Colori disponibili dark-Starwhite. Compatibile con base PL1DS-PL1BS.
- Zined and epoxy coated steel carter. Available colors dark-Starwhite. Compatible with base PL1DS-PL1BS.
- Verzinkter und pulverbeschichteter Stahlcarter. Erhaeltliche Farben dark-Starwhite. Kompatibel mit Staender PL1DS-PL1BS.
- Carter acier galvanisé et vernis. Couleurs disponibles dark-Starwhite. Compatible avec socle PL1DS-PL1BS.
- Carter de acero galvanizado y pintado. Colores disponibles dark-Starwhite. Compatible con base PL1DS-PL1BS.
- Gegalvaniseerd en geepoxeerde metaalcarter. Beschikbare kleuren dark-Starwhite. Compatibel met basis PL1DS-PL1BS.

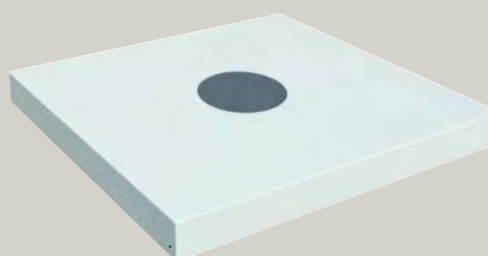

BDCS



BDWS

		KG 
BDCS	1130x1130x120 mm	21 Kg
BDWS		

BDC8080



- Carter acciaio zincato e verniciato a polveri. Colori disponibili Dark-Starwhite. Compatibile con base BUD8080.
- Zined and epoxy coated steel carter. Available colors Dark-Starwhite. Suitable for base BUD8080.
- Verzinkter und pulverbeschichteter Stahlcarter. Erhaeltliche Farben Dark-Starwhite. Kombinierbar mit Staender BUD8080.
- Carter acier galvanise' et vernis. Couleurs disponibles Dark-Starwhite. Combinable avec pied BUD8080.
- Carter de acero galvanizado y pintado. Colores disponibles Dark-Starwhite. Combinable con base BUD8080.
- Gegalvaniseerd en geepoxeerde metaalcarter. Beschikbare kleuren Dark-Starwhite. Combineerbaar met parasolvoet BUD8080.



BDC8080DS



BDC8080BS

		KG 
BDC8080DS	890x890x140 mm	21 Kg
BDC8080BS		

BUD8080

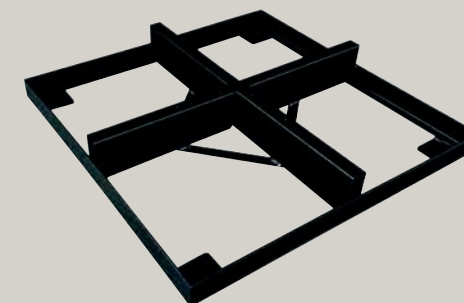

- Base a croce metallica opzionale per ombrellone a braccio da completare con 12 BC4040, non comprese. Compatibile con kit ruote B8080R.
- Optional cross metal base for cantilever parasols to be completed with 12 BC4040, not included. Compatible with wheel kit B8080R.
- Alternativer Stahlplattenstaender fuer Seitenarmschirme zum kombinieren mit 12 BC4040, nicht inbegriffen. Kompatibel mit Rollen B8080R.
- Pied en acier optionnelle pour parasols bras deporté à combiner avec 12 BC4040, non inclus. Compatible avec kit roulettes B8080R.
- Base de metal opcional para sombrillas brazo lateral para completar con 12 BC4040, no incluido. Compatible con juego de ruedas B8080R.
- Optionele metalen basis voor arm parasol uit te voeren met 12 BC4040, niet inbegrepen. Compatibel met wielkit B8080R



BUD8080DS



BUD8080BS

		KG 
BUD8080DS	890x890x140 mm	21 Kg
BUD8080BS		

B8080R

- Kit ruote alta resistenza girevoli e frenanti.
- High resistance rotating and braking wheels kit.
- Hochwiderstands-dreh- und bremsrad set.
- Kit roues rotatives et freinage haute résistance.
- Kit ruedas giratorias y frenos de alta resistenci.
- Kit met hoge weerstand draaiende en remwielen.



BALLAST

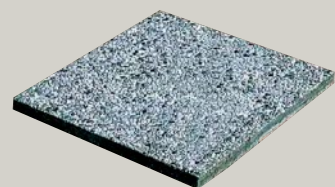

BC4040	400x400 mm	14 Kg
BC5050	500x500 mm	20 Kg

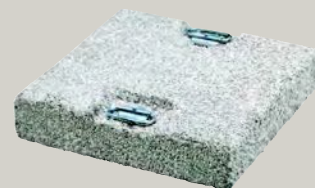

BC5151	500x500 mm	60 kg
---------------	------------	-------



BC5151G	500x500 mm	60 kg
----------------	------------	-------



BV5050G	500x500 mm	270 mm	80 kg
----------------	------------	--------	-------



BV5050B	500x500 mm	270 mm	80 kg
----------------	------------	--------	-------

BC4040 - BC5050

- Piastra in cemento e graniglia. Spessore 4 cm.
- Cement grit slab. Thickness 4 cm.
- Kiesbetonplatte. Dicke 4 cm.
- Dalles ciment et grès. Epaisseur 4 cm.
- Planchas de hormigón y de grava. De espesor 4 cm.
- Gewassen grindtegel. Dikte 4 cm.

BC5151

- Piastra in cemento e graniglia bianca con maniglie. Spessore 11cm. Per ombrelloni a braccio.
- White cement grit slab with handles. Thickness 11cm. For cantilever parasols.
- Weisse Kiesbetonplatte mit Handgriffen. Dicke 11cm. Fuer Pendelschirme.
- Dalles ciment et grès avec poignées blanc. Epaisseur 11cm. Pour parasols avec bras deporté.
- Placas blancas de hormigón y arena con asas. De espesor 11 cm. Para parasoles con voladizo.
- Wit gewassen grindtegel met handgrepen. Dikte 11 cm. Geschikt voor vrijhangende parasols.

BC5151G

- Piastra in cemento grigio con maniglie. Spessore 11cm. Per ombrelloni a braccio.
- Concrete grey cement slab with handles. Thickness 11cm. For cantilever parasols.
- Grauer Betonplatte mit Handgriffen. Dicke 11cm. Fuer Pendelschirme.
- Dalles ciment couleur gris avec poignées. Epaisseur 11cm. Pour parasols avec bras deporté.
- Base de cemento gris con asas. De espesor 11 cm. Para parasoles con voladizo.
- Betontegel grijs met handgrepen. Dikte 11 cm. Geschikt voor vrijhangende parasols.

BV5050G

- Vaso in cemento grigio con maniglie. Spessore 11cm. Per ombrelloni a braccio.
- Concrete grey cement pot with handles. Thickness 11cm. For cantilever parasols.
- Grauer Betontopf mit Handgriffen. Dicke 11cm. Fuer Pendelschirme.
- Vase ciment couleur gris avec poignées. Epaisseur 11cm. Pour parasols avec bras deporté.
- Maceta de cemento gris con asas. De espesor 11 cm. Para parasoles con voladizo.
- Plantenschaal grijs met handgrepen. Dikte 11 cm. Geschikt voor vrijhangende parasols.

BV5050B

- Vaso in cemento bianco con maniglie. Spessore 11cm. Per ombrelloni a braccio.
- Concrete white cement pot with handles. Thickness 11cm. For cantilever parasols.
- Weisser Betontopf mit Handgriffen. Dicke 11cm. Fuer Pendelschirme.
- Vase ciment couleur blanc avec poignées. Epaisseur 11cm. Pour parasols avec bras deporté.
- Maceta de cerámica con asas de hormigón. De espesor 11 cm. Para parasoles con voladizo.
- Plantenschaal beton met handgrepen. Dikte 11 cm. Geschikt voor vrijhangende parasols.

GROUND FIXING

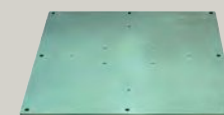

CP3030ZS	300x300 mm	7 Kg
-----------------	------------	------



CP3030ZS	650x650 mm	30 kg
-----------------	------------	-------

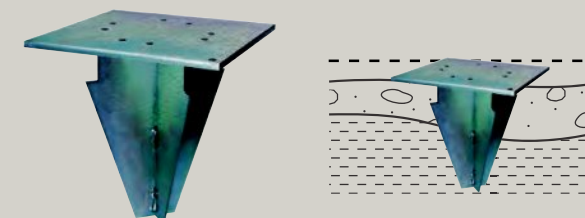

BTBS

- Supporto da interrare. acciaio zincato.
- In ground anchor. zined steel.
- Bodenanker. Verzinktes stahl.
- Base pour ancrage au sol. acier galvanisé.
- Base para fijación a tierra. acero galvanizado.
- Grondanker. gegalvaniseerd staal.



BTBS	300x300 mm	10 kg
-------------	------------	-------



BTAZS

- Supporto da interrare. Acciaio zincato.
- In ground anchor. Zined steel.
- Bodenanker. Verzinktes Stahl.
- Base pour ancrage au sol. Acier galvanisé.
- Base para fijación a tierra. Acero galvanizado.
- Grondanker. Gegalvaniseerd staal.



BTAZS	Ø 160 mm	350 mm	5 kg
--------------	----------	--------	------



La base e l'eventuale zavorra sono fondamentali per garantire stabilità e sicurezza. Selezionare l'opzione adeguata al momento dell'ordine. In caso di fissaggio a terra si esclude il rischio di ribaltamento dell'ombrellone, ma non il cedimento strutturale di alcuni componenti se sottoposti a condizioni atmosferiche incompatibili con l'uso dei ns prodotti. Queste tabelle sono indicative e prevedono che il pavimento o il terreno di appoggio sia perfettamente piano e regolare. Gli ombrelloni e i rispettivi componenti delle basi devono essere assemblati correttamente rispettando le istruzioni di montaggio. La stabilità degli ombrelloni può variare nel caso di condizioni atmosferiche particolari. L'utilizzatore finale è responsabile del corretto uso dell'ombrellone. Nessuna rivalsa può essere fatta sul produttore.

EN

The base and any ballast are essential to ensure stability and safety. Please select the appropriate option when ordering. In case of ground fixation, the risk of overturning of the parasol is excluded, but not the structural failure of some components, if subjected to atmospheric conditions that are incompatible with the use of our products. This schedule considers statics calculation and foresees that the floor where the parasol has to be positioned is perfectly flat and regular. The parasols and components have to be assembled correctly and respecting the assembly instruction. The schedule has to be considered indicative because many variables that depend from the area of employ and position of the parasols are not foreseeable. No rights can be derived from this. The use of a parasol is always on your own responsibility.



DE

Der Staender und eventueller Ballast sind grundlegend um Stabilitaet und Sicherheit zu gewaehrleisten. Bitte waehlen Sie bei der Bestellung die entsprechende Option aus.

Bei Bodenbefestigung ist das Risiko des Umkippens des Schirms ausgeschlossen, aber nicht das strukturelle Versagen einiger Bestandteile, wenn es atmosphärischen Bedingungen ausgesetzt wird, die mit der Verwendung unserer Produkte nicht vereinbar sind. Diese Aufstellung beinhaltet statistische Kalkulationen und sieht vor, dass der Schirm auf einem ebenen und regemaessigen Boden positioniert wird. Der Schirm und die Bestandteile des Staenders muessen gemaess Anbauanleitungen montiert werden. Die Stabilitaet der Schirme kann auf Grund besonderer klimatischen Konditionen aendern. Der Endbenutzer ist fuer die ordnungsgemaesse Verwendung des Schirmes verantwortlich.

FR

La base et les eventuels poids sont essentiels pour assurer la stabilité et la sécurité. Svpl. sélectionnez l'option appropriée lors de la commande. En cas de fixation au sol, le risque de renversement du parasol est exclu, mais pas la défaillance structurelle de certains composants s'ils sont soumis à des conditions atmosphériques incompatibles avec l'utilisation de nos produits. Ces tableaux sont à titre indicatif et ils prévoient que la surface sur laquelle est implanté le parasol soit parfaitement plane et lisse. Les parasols et les éléments respectifs des bases doivent être assemblés en respectant scrupuleusement les instructions de montage. La stabilité des parasols peut varier dans le cas de conditions atmosphériques particulières et dépend du lieu et de l'utilisation propre à chaque utilisateur (le parasol doit être fermé en cas de vent fort et/ou de mauvaises conditions météorologiques).

ES

La base y posible balasto son fundamentales para garantizar la estabilidad y la seguridad. Seleccione la opción adecuada al realizar el pedido. En caso de fijación al suelo, se excluye el riesgo de vuelco del parasol, pero no el fallo estructural de algunos componentes si se someten a condiciones atmosféricas incompatibles con el uso de nuestros productos. Estos cuadros son indicativos y requieren que el suelo o el apoyo de tierra sea perfectamente plano y liso. El parasol y los respectivos componentes de la base deben ser montados correctamente respetando las instrucciones. La estabilidad de los parasoles puede variar según las condiciones atmosféricas.

NL

Basis en eventuele ballast zijn essentieel om stabiliteit en veiligheid te garanderen. Selecteer alstublieft de juiste optie bij het bestellen. In het geval van bevestiging aan de grond is het risico dat de parasol omvalt uitgesloten, maar niet het structurele falen van sommige onderdelen als ze worden blootgesteld aan atmosferische omstandigheden die onverenigbaar zijn met het gebruik van onze producten. Dit schema houdt rekening met statische berekeningen en gaat ervan uit dat de vloer waarop de parasol moet worden geplaatst perfect vlak en regelmatig is. De parasols en onderdelen moeten correct en volgens de montagehandleiding worden gemonteerd. Het schema moet als indicatief worden beschouwd omdat veel variabelen die afhangen van het werkgebied en de positie van de parasols niet te voorzien zijn.

STABILITY

1

- Peso minimo richiesto
- Minimum required weight
- Erforderliches Mindestgewicht
- Poids minimum requis
- Peso mínimo requerido
- Minimaal vereist gewicht

2

- Stabilità intermedia
- Intermediate stability
- Mittlere Stabilität
- Stabilité intermédiaire
- Estabilidad intermedia
- Gemiddelde stabiliteit

3

- Peso consigliato in condizioni normali
- Recommended weight under normal conditions
- Empfohlenes Gewicht unter normalen Bedingungen
- Poids recommandé dans des conditions normales
- Peso recomendado en condiciones normales
- Aanbevolen gewicht onder normale omstandigheden

4

- Massima stabilità con base
- Maximum stability with base
- Maximale Stabilität mit Staender
- Stabilité maximale avec socle
- Máxima estabilidad con base
- Maximale stabiliteit met voet

5

- Massima stabilità con fissaggio a terra
- Maximum stability with ground fixation
- Maximale Stabilität bei Bodenbefestigung
- Stabilité maximale avec fixation au sol
- Máxima estabilidad con fijación al suelo
- Maximale stabiliteit door bodembevestiging



- In caso di base con ruote, prestare particolare attenzione in caso di vento. Prima di spostare l'ombrellone è necessario chiuderlo.
- In case of base with wheels, be especially careful in windy conditions. Close the parasol before moving it.
- Bei Staender mit Räder und Wind besonders vorsichtig sein. Der Schirm kann geschlossen bewegt werden.
- Dans le cas d'une base à roues, faites particulièrement attention par temps venteux. Avant de déplacer le parasol, il est nécessaire de le fermer.
- En el caso de una base con ruedas, tenga especial cuidado en condiciones de viento. Antes de mover la sombrilla es necesario cerrarlo.
- Wees vooral voorzichtig met statieven met wielen en wind. De parasol kan in gesloten toestand worden verplaatst.

		BASES						GROUND FIXING			
		BC35MA4	BC55MA4	BC80MA4	BC5151GRA4	BF6565D BF6565W	BF6666D BF6666W	BUD8080 +N°12 BC4040	BQ8080 +N°8 BC4040	BTC +BTT	CP3030ZS +BTT
PALLADIO	∅ 2,5	1	3	4		3	4	/	/	5	5
LIDO		1	3	4		3	4	/	/	5	5
PALLADIO	∅ 3,0	/	3	4		3	4	/	/	5	5
NAPOLI RIMINI		/	2	3		2	3	/	4	5	5
PALLADIO	∅ 3,5	/	2	3		2	3	/	4	5	5
PALLADIO	∅ 4,0	/	1	2	/	1	2	4	3	5	5
PALLADIO TEL.	∅ 5,0	/	/	1	/	/	1	3	2	5	5
VELA LIDO		1	3	4		3	4	/	/	5	5
PALLADIO	2,0 x 2,0	1	3	4		3	4	/	/	5	5
VELA		/	2	3		2	3	5	4	5	5
PALLADIO	3,0 x 3,0	/	2	3		2	3	5	4	5	5
NAPOLI RIMINI		/	2	3		2	3	5	4	5	5
PALLADIO	3,5 x 3,5	/	1	2	/	1	2	4	3	5	5
LEONARDO		/	1	2	/	1	2	4	3	5	5
PALLADIO	4,0 x 4,0	/	/	1	/	/	1	4	3	5	5
LEONARDO PALLADIO TEL.		/	/	1	/	/	1	4	3	5	5
NAPOLI		/	3	4		3	4	/	/	5	5
PALLADIO	2,0 x 3,0	/	3	4		3	4	/	/	5	5
NAPOLI RIMINI		/	1	2	/	1	2	4	3	5	5
PALLADIO	3,0 x 4,0	/	1	2	/	1	2	4	3	5	5
LEONARDO PALLADIO TEL.		/	1	2	/	1	2	4	3	5	5

	B1					PL1				BUD8080				GROUND FIXING				
	B1DS/B1BS	n°2 BC5151 n°6 BC5050	n°4 BC5151 n°12 BC5050	n°2 BV5050	BCCS/BCWS	PL1DS/ PL1BS	n°4 BC5151 n°12 BC5050	n°4 BV5050	BDCS/BDWS	BUD8080	+n°12 BC4040	B8080R	BUD8080DS BUD8080BS	CP3030ZS	CP6565ZS	BTBS	BTAZS	
SIDE POST	Ø 3,5	◆	1	3	2	◆	4	5	◆		3	/		5	5	/	5	
	Ø 4,0	◆	1	3	2	◆	4	5	◆		3	/		5	5	/	5	
	3,0 x 3,0	◆	1	3	2	◆	4	5	◆		3	/		5	5	/	5	
	3,5 x 3,5	◆	1	3	2	+12 BC5050	◆	4	5	+12 BC5050	◆	3	/	+12 BC4040	5	5	/	5
	4,0 x 4,0	◆	1	/	/	◆	2	3	◆		/	/		5	5	/	5	
	2,0 x 3,0 3,0 x 2,0	◆	/	3	2	◆	4	5	◆		3	/		5	5	/	5	
	3,0 x 4,0	◆	1	3	2	◆	4	5	◆		3	/		5	5	/	5	
GALILEO	3,0 x 3,0	◆	1	3	2	◆	4	5	◆		3	🚫		5	5	/	5	
	3,5 x 3,5	◆	/	2	1	+12 BC5050	◆	3	4	◆	2	🚫	+12 BC4040	5	5	/	5	
	4,0 x 4,0	◆	/	/	/	◆	2	3	◆		/	/		5	5	/	5	
	3,0 x 4,0	◆	/	2	1	◆	3	4	◆		2	🚫		5	5	/	5	
CAPRI	4,0 x 4,0	◆	/	/	/	◆	4	5	◆		3	🚫		/	5	5	/	
	5,0 x 5,0	◆	/	/	/	◆	2	4	◆		/	/		/	5	5	/	
	6,0 x 6,0	◆	/	/	/	+12 BC5050	◆	1	3	+12 BC5050	◆	/	/	+12 BC4040	/	5	5	/
	3,0 x 4,0	◆	/	/	/	◆	4	5	◆		3	🚫		/	5	5	/	
	5,0 x 6,0	◆	/	/	/	◆	1	3	◆		/	/		/	5	5	/	
DOUBLE	3,0 x 6,0	◆	/	/	/	+12 BC5050	◆	2	4	+12 BC5050	◆	/	/	/	5	5	/	
	3,5 x 7,0	◆	/	/	/	◆	1	3	◆		/	/		/	5	5	/	
POKER	6,0 x 6,0	◆	/	/	/	+12 BC5050	◆	2	3	+12 BC5050	◆	/	/	+12 BC4040	/	5	5	/
	7,0 x 7,0	◆	/	/	/	◆	2	3	◆		/	/		/	5	5	/	

MATERIALI E FINITURE

MATERIALS AND FINISHING

COMPONENTI E PROFILI ALLUMINIO

ALUMINIUM COMPONENTS AND PROFILES



ALUMINIUM DARK

- Napoli Standard / Braccio
- Leonardo Braccio / Telesc.
- Palladio Braccio
- Torino Braccio
- Galileo Dark
- Galileo Maxi Dark
- Alu Poker / Double Dark
- Wood Poker / Double
- Capri Dark
- Lido



ALUMINIUM STARWHITE

- Rimini standard
- Rimini Braccio
- Pompei
- Galileo
- Galileo Maxi
- Capri
- Lido



ALU TITANIUM

- Lido Titanium
- Vela Titanium



ALUMINIUM IROKO

- Torino Braccio
- Palladio Braccio
- Wood Double
- Galileo Wood



ACCESSORIES



ALUMINIUM DARK

- Napoli Standard / Braccio
- Leonardo Braccio/Telescopic
- Galileo Dark
- Galileo Maxi Dark
- Alu Poker / Double Dark
- Lido

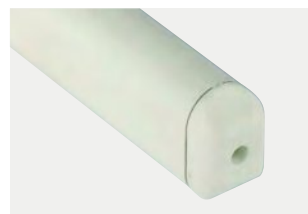

ALUMINIUM STARWHITE

- Rimini standard
- Rimini Braccio
- Pompei
- Galileo
- Galileo Maxi
- Lido



ALU TITANIUM

- Lido Titanium
- Vela Titanium

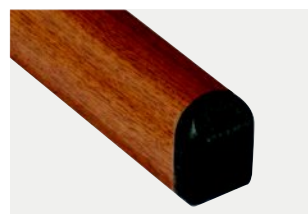

ALU IROKO

- Galileo Wood



IROKO WOOD

- Palladio Standard
- Palladio Braccio
- Palladio Telescopic
- Torino



Standard

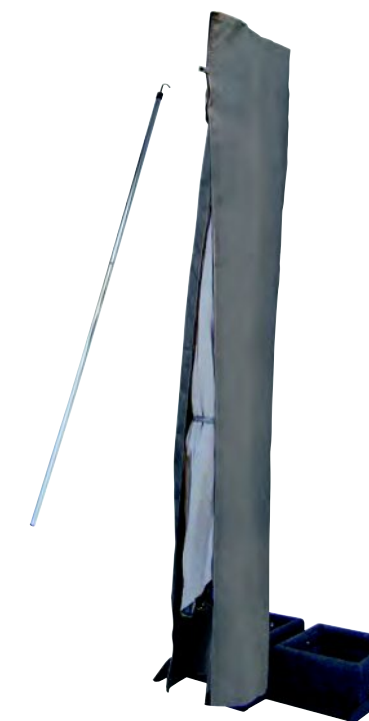

Galileo



Braccio

FABRIC COLLECTION



FATTORE DI PROTEZIONE SOLARE
Limita il passaggio del calore per più del 70%.

SOLAR PROTECTION FACTOR
Harmful UV rays and limiting heat circulation



FATTORE DI PROTEZIONE LUMINOSA
Indica la percentuale di trasmissione della luce

FACTOR OF SOLAR LIGHT PROTECTION
% of light trasmission



FATTORE DI PROTEZIONE UPF
Protezione dai raggi U.V. (UPF) dal 85% al 100%

UPF PROTECTION FACTOR
Harmful UV rays. (UPF) from 85% almost 100%

SCHEDA TECNICA / DATA SHEET

COMPOSIZIONE / COMPOSITION	CARATTERISTICHE / FINISHING	SOLIDITÀ AL COLORE / COLOR FASTNESS	TRATTAMENTO / TREATMENT	IMPERMEABILITÀ / COLONNA D'ACQUA / IMPERMEABILITY / WATER COLUMN
350 gr/m ² 100% acryl	Inattaccabile da muffe e batteri. Solido alla luce Permeabile all'aria Antimacchia - Resistant to mould and bacteria. Solid to light Air permeable Stain resistant	Grado 7/8 ensio 105-b04 - Grade 7/8 ensio 105-b04	Resine teflon idro-oleorepellenza - Teflon resins water-oil repellent	circa 25 cm - about 25cm

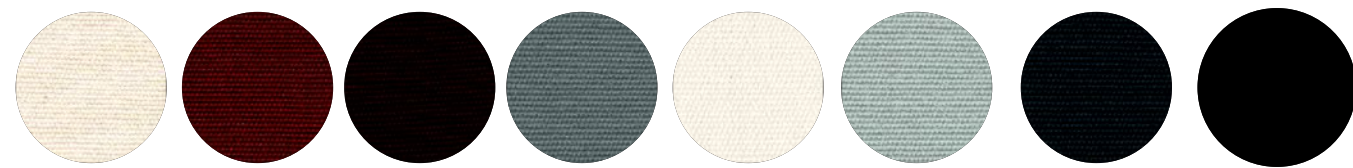

350 GR/M ² ACRYLIC	A1 ECRU NATURAL COL. NATUR	T2 TERRACOTTA ZIEGELROT TERRACOTTA	T3 BORDEAUX	T6 GRIGIO TAUPE GREY TAUPE GRAU TAUPE GRIS TAUPE GRIJS TAUPE	T7 BIANCO WHITE BLANC WEISS	T8 GRIGIO PERLA SILVER GREY SILBERGRAU	T9 GRIGIO ANTRACITE ANTHRACIT GREY ANTHRAZITGRAU	S1 NERO /BLACK SCHWARZ NOIRE NEGRO ZWART
-------------------------------	-------------------------------------	---------------------------------------------	----------------	--------------------------------------------------------------------------------	-----------------------------------------	-------------------------------------------------	--------------------------------------------------------------	---------------------------------------------------------

	A1	T2	T3	T6	T7	T8	T9	S1
	70/80%	> 90%	> 90%	> 90%	70/80%	> 90%	> 90%	> 90%
	20/30%	< 10%	< 10%	< 10%	20/30%	< 10%	< 10%	< 10%
	85/89%	100%	100%	100%	85/89%	100%	100%	100%

I dati forniti, pur essendo frutto di misurazioni scientifiche condotte in laboratori certificati, sono da ritenersi indicativi.
The above mentioned data are indicative, although provided by scientific measurements performed in certified laboratories.



EXCLUSIVE FABRIC COLLECTION

350GR/M² ACRYLIC

- Gamma tessuti a richiesta. Tessuto mano tende.
- Fabric range on request. Awning fabrics.
- Farbkollektion auf Anfrage. Markisenstoffe.
- Gama de telas bajo pedido. Telas de toldos.
- Kleurencollectie op aanvraag. Zonweringdoek.



> 90%



< 10%



100%

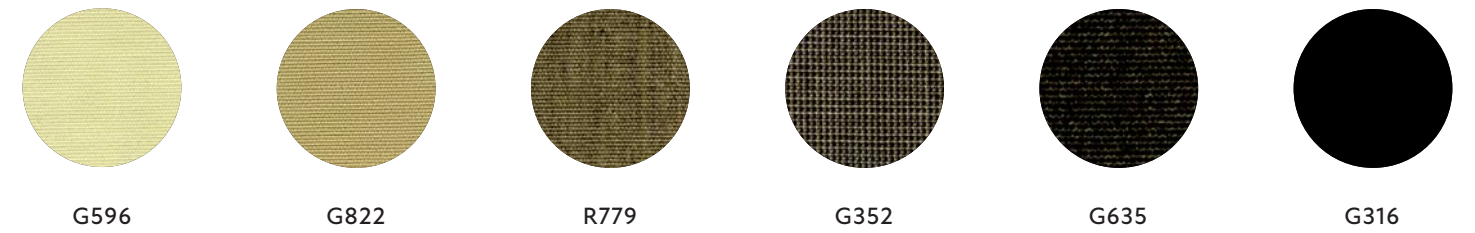

G596

G822

R779

G352

G635

G316

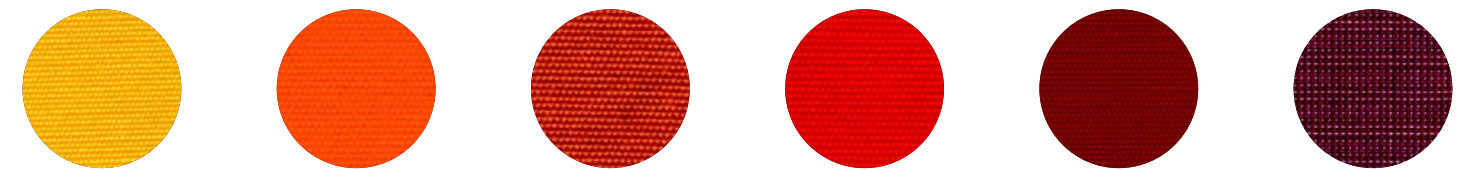

G013

G050

R777

G211

G209

G055

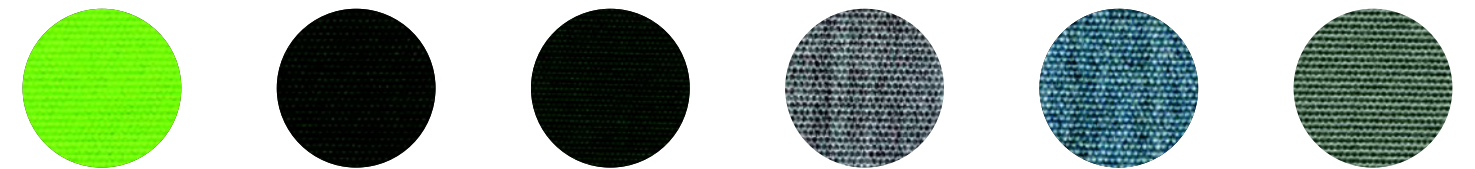

G024

R023

G245

G365

G636

G396

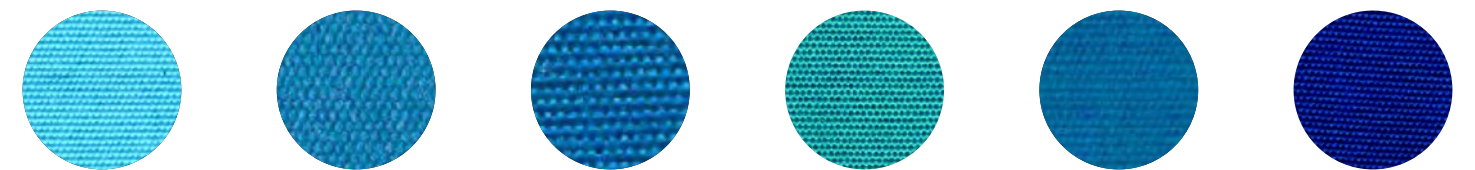

G066

G216

G189

G329

G204

G235



G018

G022

R051

G785

G285

G119

KIT LED PRO/CAPRI

WHITE 3000K
KIT LED 50 CM WHITE

CAPRI
KIT LED 120 CM WHITE



CABLAGGIO DORSALE LED BIANCO
WHITE WIRING



TELECOMANDO IR
REMOTE CONTROL

B: BATTERIA / BATTERY



CARICA BATTERIA
BATTERY CHARGER

BATTERIA
BATTERY

C: CORRENTE / POWER



ALIMENTATORE 220V
220V POWER SUPPLY



IT

Kit completo di luci a led ad alta luminosità sviluppato per le esigenze del settore professionale. Si può applicare a tutti gli ombrelloni a braccio laterale e Capri di nostra produzione anche successivamente alla consegna; non é quindi necessaria una predisposizione all'origine.

Il kit é composto da:

- 4 profili tubolari a Led orientabili IP65 in PMMA satinato, per utilizzo esterno, da applicare alle stecche dell'ombrellone;
- profili a Led disponibili con due diverse lunghezze: 50 cm per gli ombrelloni a braccio e 120 cm per il modello Capri;
- luce a Led bianco 3000K;
- batteria ricaricabile con autonomia minima di 8 ore, completa di contenitore IP56 e carica batteria;
- oppure alimentatore elettronico stabilizzato 220Vac - 12Vdc 60W;
- telecomando IR;
- cablaggio completo per utilizzo in esterno;
- Nuovo sistema di fissaggio semplificato con calamita.

EN

Complete high light LED kit developed for the professional and commercial fit. Usable on all our cantilever parasols and model Capri, even after the supply. It is therefore not necessary to foresee the predisposition from the beginning.

The Led Kit is composed by

- 4 tubular profiles with orientable IP65 in PMMA satin finish, for external use, to be applied on the parasol ribs;
- led profiles available with two different lengths: 50 cm for cantilever parasols and 120 cm for Capri model;
- white Led Light 3000K;
- rechargeable battery with a minimum battery life of 8 hours, including IP56 box and battery charger;
- or stabilized electronic power supply 220Vac - 12Vdc 60W;
- IR remote control;
- complete wiring for outdoor use;
- New simplified fixing system with magnet.

Per ombrelloni a braccio. Barre led da 50 cm
For cantilever parasols. Led strips 50 cm

Per ombrelloni Capri. Barre led da 120 cm
For Capri parasol. Led strips 120 cm

Descrizione / Description	Cod.	Cod.
luce bianca - con collegamento elettrico white light - electrical - connection	KIT LED 50 W - C	KIT LED 120 W - C
luce bianca - kit batteria white light - battery kit	KIT LED 50 W - B	KIT LED 120 W - B



USO E MANUTENZIONE

INDICAZIONI

- Prima dell'uso, conservare e leggere attentamente i manuali e le istruzioni di montaggio che si trovano all'interno della confezione.
- La base deve essere zavorrata. Un peso insufficiente compromette seriamente la stabilità dell'ombrellone.
- Rimuovere sempre la manovella quando non in uso e tenerla fuori dalla portata dei bambini.
- Per evitare danni o lesioni personali, l'ombrellone deve essere chiuso e in alcune condizioni atmosferiche avverse potrebbe essere necessario rimuovere il prodotto e stoccarlo in luogo protetto. Ricorda sempre che l'ombrellone non è una costruzione fissa. La ditta Scolaro non può essere ritenuta responsabile per danni alla merce fornita, o lesioni derivanti da un uso improprio e dal mancato rispetto delle istruzioni e delle linee guida fornite.

IMPIEGO DEL PRODOTTO

Prima di iniziare ad aprire l'ombrellone, assicurarsi che il tessuto non sia rimasto impigliato nelle stecche interne. Per aprire o chiudere l'ombrellone ruotare la maniglia (dove presente) nel senso indicato dalle frecce e dalla scritta "Apri" o "Chiudi". Un funzionamento errato potrebbe strappare la corda o danneggiare il meccanismo. Non forzare mai le corde o maniglie. Se si bloccano, controlla perché è successo ed elimina la possibile causa. Parti in legno: applicare un impregnante per legno a base di cera almeno una volta all'anno prima della stagione invernale. Chiudere l'ombrellone quando le condizioni meteorologicxhe non sono adatte, ad es. forte vento o pioggia battente. Gli ombrelloni Scolaro possono essere abbinati a basi speciali sviluppate per il fissaggio a terra. Qualora si decida di posizionare un ombrellone Scolaro utilizzando solo zavorra, ne viene certificata l'idoneità all'utilizzo in condizioni di vento moderato. Nella tabella specifica sono indicate le zavorre minime. Il Cliente è l'unico responsabile dell'installazione e della gestione dell'ombrellone.

ACCIAIO INOSSIDABILE

Attenzione:

1. NON UTILIZZARE I SEGUENTI PRODOTTI su parti in acciaio inossidabile: Candeggina a base di cloro o detersivi contenenti candeggina (possono corrodere l'acciaio inossidabile). Acido cloridrico o prodotti contenenti cloruri (possono corrodere l'acciaio inossidabile).
2. Il sale, il calcare o gli acidi (bevande e alimenti) possono scolorire le parti in acciaio inossidabile se non pulite tempestivamente.
3. I prodotti o le parti in acciaio inossidabile utilizzati in prossimità del mare o per la decorazione interna delle piscine richiedono una pulizia più frequente per rimuovere i cloriti depositati e per prevenire la corrosione e il deterioramento chimico delle superfici esterne.
4. Macchie o ruggine rilevate sulle superfici in acciaio inossidabile devono essere pulite tempestivamente.
5. Le macchie non rimosse per lunghi periodi possono diventare permanenti.
6. La ruggine può causare reazioni chimiche o corrodere l'acciaio inossidabile.

Per rimuovere macchie o ruggine:

- Applicare un detergente o lucidante specifico non abrasivo per acciaio inox.
- Sciacquare accuratamente con acqua pulita.
- Infine asciugare bene per evitare che si formino striature, sfregamento nel senso delle fibre.

METALLI VERNICIATI: FERRO E ALLUMINIO

Per una lunga durata dell'ombrellone si consiglia di riporlo in ambienti asciutti, durante il periodo invernale e quando non utilizzato. Si consiglia inoltre di controllare una volta a stagione, soprattutto dopo un lungo periodo di inattività, il corretto funzionamento di tutti i componenti. La nostra garanzia non copre alcun tipo di graffio o abrasione alla finitura causata dal contatto con altri arredi o dalla conseguente corrosione. L'impiego in ambienti marini può portare all'accumulo di sali e cloruri sulla verniciatura a polvere. La mancata esecuzione di una regolare pulizia con acqua dolce può causare la formazione di bolle, ossidazioni, scolorimento e invalidare la garanzia. Per la pulizia delle superfici in metallo verniciato utilizzare acqua fredda e detersivi liquidi non abrasivi o aggressivi. Applicare con un panno morbido. Nel caso di superfici molto sporche e/o invecchiate, dopo la pulizia, si consiglia di trattarle con paraffina liquida. In caso di macchie causate da depositi di calcare su vernici di struttura grossolana (es. ferro antico e marrone d'india) pulirle con uno straccio e una soluzione di aceto di vino bianco diluito in acqua fredda.

LEGNO: IROKO

Legno tradizionale impiegato per l'arredo esterno e l'industria nautica. L'Iroko è un legno duro ad alto contenuto di olio, adatto per uso esterno. Estremamente duraturo. È praticamente inalterabile alla ripetuta esposizione agli agenti atmosferici. Anche se trattato, la superficie assume una patina grigio argento che è la naturale protezione dall'interno del legno, considerato parte essenziale del fascino dell'Iroko. La naturale tendenza del legno ad ingrigire o perdere la brillantezza della vernice può essere prevenuta nelle prime fasi di vita del prodotto. L'ombrellone può essere ripristinato mediante un nuovo trattamento con adeguato prodotti facilmente reperibili nei negozi specializzati. È necessario applicare una soluzione di acqua e olio incolore, a superfici esposte con un panno. L'olio deve essere molto diluito. Le macchie superficiali possono essere rimosse intervenendo per tempo, prima che il legno possa assorbirle completamente. Carteggiare delicatamente la superficie in questione e poi lucidare con un panno ruvido.

TESSUTI SINTETICI: ACRILICO E POLIESTERE

Il tessuto è impermeabile e trattato antimuffa per respingere l'acqua, le macchie e garantire la traspirazione. Si prega di seguire le nostre istruzioni di manutenzione per garantire la lunga durata del tessuto:

- Rimuovere spesso depositi di polvere, macchie e qualsiasi tipo di sporco per evitare tracce dopo la pulizia.
- È molto importante chiudere l'ombrellone solo quando è perfettamente asciutto. Durante l'inverno e quando l'ombrellone non viene utilizzato, deve essere conservato in un ambiente asciutto. Evitare il contatto prolungato con sostanze oleose e/o coloranti che potrebbero essere assorbite dal materiale di rivestimento in PVC e causare macchie permanenti, oltre a danneggiare la struttura del filo. Non utilizzare solventi o detersivi a base di solventi (evitare l'acetone). Usare acqua e detersivi liquidi non abrasivi, incolore, a PH neutro. Lasciare agire il detersivo per qualche minuto. Risciacquare bene con acqua non più calda di 30°C.

COMPONENTI

I componenti in acciaio, la viteria e gli accessori sono trattati antiruggine. Comunque per una lunga durata dell'ombrellone, durante l'inverno e quando non viene utilizzato, l'ombrellone deve essere conservato in ambiente asciutto. Durante ogni stagione è necessario verificare la funzionalità di tutti i componenti, soprattutto dopo un lungo periodo di inattività. La ditta Scolaro è a vostra disposizione per assistenza tecnica.

GARANZIA

Gli ombrelloni Scolaro sono progettati per durare molti anni esposti all'uso esterno.

Come per molti articoli, l'attenzione nell'uso e nella manutenzione e il rispetto delle istruzioni contenute in queste pagine, permette una vita media ancora più lunga del prodotto e la possibilità di godere di un prodotto ancora più efficiente ed esteticamente gradevole.

I prodotti Scolaro sono garantiti 2 anni.

Se si rispettano le indicazioni e i consigli, la garanzia può essere estesa come segue:

LA GARANZIA COPRE SOLO I DIFETTI DI FABBRICAZIONE DI INTEGRITÀ STRUTTURALE. LA GARANZIA NON COPRE DANNI CAUSATI DA AZIONI MECCANICHE, FORZA NATURALE E ATTI DOLOSI.

5 anni di garanzia sui componenti in alluminio e acciaio inox. Inclusa verniciatura e viti.

- Difetti strutturali non derivanti da uso improprio o mancata manutenzione.
- Corrosione invasiva non prodotta da graffi o abrasioni da utilizzo non asportabile mediante normale pulizia e manutenzione.

5 anni di garanzia sui colori e sul trattamento dei tessuti (resistenza).

- La sostituzione della coperta durante il periodo di garanzia è prevista solo in caso di scolorimento prima della fine del periodo di garanzia. Gli utenti devono conservare correttamente i tessuti, affinché la garanzia sia effettiva. Una corretta manutenzione implica una pulizia regolare.
- La garanzia non copre i danni da contatto con oggetti estranei, abrasioni causate dal vento, uso improprio o abuso (strappi, bruciature e fori). L'uso intensivo in ambiente aggressivo (mare e piscina), richiede un regolare risciacquo del tessuto con acqua dolce per prevenire ed evitare l'accumulo di residui salini e clorurati.

2 anni di garanzia su tutti gli elementi metallici e in acciaio in genere

1 anno di garanzia sui meccanismi di apertura con manovella, previo uso corretto e rispettoso delle istruzioni fornite.

2 anni di garanzia in genere per le finiture e altri materiali non specificatamente menzionati e scritti sopra, comprese le basi in cemento e le zavorre

1 anno di garanzia sui kit luci LED e sui componenti elettrici in general.

LA GARANZIA NON SI APPLICA:

- Se il prodotto non è stato assemblato secondo le istruzioni fornite;
- in caso di uso improprio del prodotto o non conforme alla normale destinazione d'uso del bene;
- in caso di mancato rispetto delle istruzioni per l'uso e la manutenzione indicate nel materiale informativo fornito con il prodotto;
- in caso di stoccaggio in condizioni ambientali non idonee al prodotto;
- in caso di modifica o manomissione del prodotto;
- se il prodotto è stato assemblato o combinato con componenti e prodotti non forniti da Scolaro.

Per usufruire della garanzia è necessario esibire l'articolo difettoso o inviare le foto, unitamente alla fattura o scontrino fiscale.

La garanzia comprende la fornitura di parti di ricambio o la sostituzione del prodotto se necessario. La garanzia non comprende la riparazione in loco o il rimborso delle spese sostenute per il mancato utilizzo del prodotto.

In caso di vizio accertato da Scolaro, si riserva il diritto - a propria discrezione - di sostituire il prodotto con uno uguale o equivalente per caratteristiche essenziali o di rimborsare al cliente solo l'importo pagato per il prodotto. Nessuna ulteriore spesa o danno potranno essere richiesti a Scolaro.

Scolaro non sarà responsabile per eventuali danni a cose o persone derivanti da un uso improprio del prodotto.

Politica di servizio e riparazioni

Anche in caso di danneggiamenti e rotture, Scolaro ha sempre adottato un'attenta e puntuale politica di assistenza post vendita.

In qualunque caso di danneggiamento o necessità, consigliamo di contattare la nostra azienda per valutare la possibilità di riparare e recuperare il prodotto, nonché per ottenere assistenza per eseguire l'intervento.

La corrispondenza ad alti standard qualitativi e funzionali dei materiali impiegati costituisce la garanzia principale della robustezza e resistenza nel tempo dei prodotti Scolaro. Un comportamento rispettoso di norme di manutenzione ed uso, come specificato di seguito, assicura una durata ancora maggiore.

Le informazioni contenute in questo catalogo o in altri stampati pubblicitari della ditta Scolaro, quali caratteristiche tecniche dei prodotti o dei componenti, dimensioni, schemi di montaggio, colori, ecc., hanno valore meramente indicativo, in ragione delle specifiche tecniche e della evoluzione tecnologica dei prodotti aziendali. Al fine di migliorare la qualità del prodotto, la ditta si riserva il diritto di modificare lo stesso senza alcun preavviso e anche dopo l'accettazione dell'ordine. L'azienda si riserva di apportare modifiche parziali o totali ai prodotti senza preavviso declinando ogni responsabilità su eventuali dati inesatti. Eventuali lievi variazioni di tonalità dei colori e delle finiture rientrano nelle normali caratteristiche dei materiali impiegati. Tutte le differenze sopraindicate non sono tali da modificare significativamente i prodotti stessi e non costituiscono motivo di reso o sostituzione della merce o di contestazione.

USE AND MAINTENANCE

DIRECTIONS

- Before use, directions and assembling instructions, which are inside the package, have to be kept and read carefully .
- The base has to be ballasted. An insufficient weight will seriously compromise the stability of the parasol.
- Always remove crank when not in use and keep out of reach of children.
- To avoid damage or personal injury, parasol must be closed and in some extreme weather conditions it may be necessary to remove the product and store it in a protected place. Remember always that the parasol is not a fixed construction. The company Scolaro cannot be held responsible for damages to goods supplied, or injury resulting from improper use and failure to follow instruction and guidelines given on.

PRODUCT EMPLOY

Before starting to open the parasol, make sure that the fabric has not got caught in the internal ribs. To open or close the parasol, turn the handle (where available) in the direction indicated by the arrows and the words "Open" or "Close". Incorrect operation could tear the string or damage the mechanism. Never force the ropes or handles. If they get stuck, check why this has happened and eliminate the possible cause. Wooden parts: apply a wax-based wood-stainer at least once a year before the winter season. Close the parasol when the weather conditions are unsuitable, strong wind or heavy rain. Scolaro parasols can be combined with special bases developed for the ground fixing. If it is decided to position a Scolaro parasol using ballast only, their suitability for use in conditions of moderate wind is certified. In the specific table the minimum ballast weights are indicated. The Customer is the sole party responsible for installing and managing the parasol.

STAINLESS STEEL

Attention:

1. DO NOT USE THE FOLLOWING PRODUCTS on any parts made of stainless steel: Chlorine bleach or detergents containing bleach (they can corrode stainless steel). Hydrochloric acid or products containing chlorides (they can corrode stainless steel).
2. Salt, limestone or acids (drinks and food) may discolour parts made of stainless steel if not cleaned promptly.
3. Products or parts made of stainless steel used near the seaside or for the interior decoration of swimming pools require more frequent cleaning in order to remove chlorites deposited on them and to prevent corrosion and chemical deterioration of the external surfaces.
4. Stains or rust noted on stainless steel surfaces must be cleaned promptly.
5. Stains left in place for long periods may become permanent.
6. Rust may cause chemical reactions or corrode stainless steel.

To remove stains or rust:

- Apply a specific non-abrasive detergent or polish for stainless steel.
- Rinse thoroughly with clean water.
- Lastly, dry thoroughly in order to prevent streaks from occurring, rubbing in the sense of the fibres.

VARNISHED METALS: IRON AND ALUMINIUM

For a long lasting of the parasol we recommend to store it in dry environments, during the winter and when not in use. It's also recommended to check once a season, especially after a long period of inactivity, the proper functioning of all components. Our warranty does not cover any type of scratches or abrasions to finish caused from the contact with other furniture or any resulting corrosion. The employ in marine environments can lead to the accumulation of salt and chlorides on the powder coating. Failure to perform regular cleaning with fresh water can cause blisters, oxidation, discoloration and invalidates the warranty. To clean surfaces in varnished metals, use cold water and non abrasive or aggressive liquid detergents. Apply with a soft cloth. In the case of very dirty and/or aged surfaces, after cleaning, it is advisable to treat them with liquid paraffin. In the event of stains caused by lime deposits on varnishes of coarse structure (eg. antique iron and indian brown) clean them with a cloth and a solution of white wine vinegar diluted in cold water.

WOOD: IROKO

Traditional wood employed for outdoor furniture and the marine industry. Iroko is a hardwood with a high oil content, suitable for external use. Extremely long-lasting. It is practically unalterable to repeated exposure to atmospheric factors. Even if treated, the surface takes a silver-grey coating which is the natural protection from inside the wood, considered an essential part of Iroko's charm. The natural tendency of wood to turn gray or lose the brightness of the paint can be prevented in the early stages of the product life. The parasol can be restored by a new treatment with proper products easy to find in specialized shops. It's necessary to apply a solution of water and colourless oil, to exposed surfaces with a cloth. The oil must be highly diluted. Superficial stains can be removed by intervening in time, before the wood can fully absorb them. Gently sand the surface in question and then polish with a rough cloth.

SYNTHETIC FABRICS: ACRYL AND POLYESTER

The fabric is waterproof and anti mould treated to reject water, spots and grant transpiration. Please follow our maintenance instruction to grant the long lasting of the fabric:

- Remove often dust deposits, spots and any type of dirt in order to avoid trails after cleaning.
- It's very important to close the parasol only when it is perfectly dry. During the winter and when the parasol is not employed, it has to be stored in dry environment. Avoid prolonged contact with oily substances and/or dyes that could be absorbed by the covering material in PVC and cause permanent stains, in addition to damaging the structure of the thread. Do not use solvents or solvent-based detergents (avoid acetone). Use water and non-abrasive, colourless liquid detergents with a neutral PH. Let the detergent act for a few minutes. Rinse well with water no warmer than 30°C.

COMPONENTS

The steel components, screws and accessories are anti rust treated. Anyway for a long lasting of the parasol, during the winter and when the it is not employed, the parasol has to be stored in dry environment. During every season it is necessary to check the functionality of all components, especially after a long period of non-employ. The company Scolaro is at your disposal for technical assistance.

WARRANTY

Scolaro parasols are designed to last for many years exposed to outdoor use.

As with many items, attention in use and maintenance and following the instructions contained in these pages, allows an even longer average life of the product and the possibility of enjoying an even more efficient and aesthetically pleasing product.

Scolaro's products are guaranteed for 2 years. If you comply with the indications and advices, the warranty can be extended as follows:

THE WARRANTY COVERS ONLY MANUFACTURING DEFECTS OF STRUCTURAL INTEGRITY. THE WARRANTY DOES NOT COVER DAMAGES CAUSED BY MECHANICAL ACTIONS, FORCE OF NATURE AND MALICIOUS ACTS.

5 years warranty on aluminum and stainless steel components. Including painting and screws.

- Structural faults not resulting from improper use or lack maintenance.
- Invasive corrosion not produced by scratches or abrasions from use not removable through normal cleaning and maintenance.

5 year warranty on colors and treatment of fabrics (strength).

- The replacement of the canopy during the warranty period is foreseen only if it loses its color before the end of the warranty period. Users must properly maintain fabrics for the warranty to be effective. Proper maintenance implies regular cleaning.
- The warranty does not cover damage from contact with foreign objects, wind-driven abrasions, misuse or abuse (tears, burns and holes). The intensive employ in an aggressive environment (seaside and pool use), requires a regular rinse of the fabric with fresh water in order to prevent and avoid the build-up of salt and chloride residues.

2 years warranty on all metal and steel elements in general

1 year warranty on the opening mechanisms with crank subject to correct and respectful use according to the instruction given.

2 years warranty in general for finishes and other materials not specifically mentioned and written above, including concrete bases and ballasts.

1 year warranty on LED light kits and electrical components in general. THE WARRANTY DOES NOT APPLY:

- If the product has not been assembled according to the instructions provided;
- in the event of improper use of the product or use that does not conform to normal intended use of the property;
- in case of non-compliance with the instructions for use and maintenance indicated in the information material supplied with the product;
- in case of storage in environmental conditions that are not suitable for the product;
- in case of modification or tampering with the product;
- if the product has been assembled or combined with components and products not provided by Scolaro.

To take advantage of the warranty the faulty item must be shown or pictures must be forwarded, together with the invoice or receipt.

The warranty includes the supply of spare parts or the replacement of the product if necessary.

The warranty does not include the repair on-site or the refund of costs incurred for non-use of the product. In case of defect confirmed by Scolaro, it reserves the right - at its own discretion - to replace the product with an equal or equivalent one for essential characteristics or to refund only the amount paid for the product to the customer.

No further expenses or damages can be requested from Scolaro. Scolaro will not be liable for any damage to properties or individuals deriving from an improper use of the product.

Service and repairs policy

Even in the event of damage and breakage, Scolaro has always adopted a careful and punctual after-sales assistance policy.

In any case of damage or need, we recommend contacting our company to evaluate the possibility of repairing and recovering the product, as well as to get assistance in carrying out the intervention.

The connection between the high qualitative and functional standards of the materials used, constitutes the main guarantee of the sturdiness and the resistance of the company's products over time. Respecting the rules of maintenance and use, specified as follows, will ensure the success of these objects, which were devised with Scolaro quality, to last a long time.

The information contained in this brochures or other Scolaro's advertisements prints, such as product specifications or components, dimensions, assembling instruction, colours, etc..., are purely indicative, because of the technical specifications and the technological evolution of the company's products. In order to improve the quality of the product, the company reserves the right to change the same without prior notice and even after acceptance of the order. The company reserves the right to make partial or complete changes to the products without prior notice and declines any responsibility for inaccurate data. Any colour differences and changes of finishing have to be considered normal characteristics of the materials used. These differences do not significantly change the products and aren't reason for return or replacement of the goods or dispute.



- Dimensione (metri)
- Dimensions (meters)
- Masse (Meter)
- Dimensions (metrès)
- Dimensiones (en metros)
- Afmeting in (meters)



- Lunghezza
- Length
- Laenge
- Longueur
- Longitud



- Peso
- Weight
- Gewicht
- Poids
- Peso
- Gewicht



- Volume (m³)
- Volume (m³)
- Volumen (m³)
- Volume (m³)
- Volumen (m³)



- Ø Palo (mm)
- Ø Pole (mm)
- Ø Mast (mm)
- Ø Mat (mm)
- Diametro mm (asta)
- Ø Mast (mm)



- Sezione sostegno (mm)
- Support section (mm)
- Mastprofil (mm)
- Section support (mm)
- Sección soporte (mm)
- Mast (mm)



- Colore dei componenti/stecche
- Component/Ribs colour
- Farbe der Bestandteile und Streben
- Couleur des composants et baleines
- Color de los componentes ò piezas/Varillas ò listones



- Stecche
- Ribs
- Streben
- Baleines
- Varillas
- Baleinen



- Set canaline
- Raingutter set
- Regerinnen
- Set gouttières
- Canalizador Lluvias
- Set regengoten

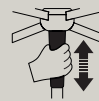

- Apertura semplificata a spinta
- Easy push opening system
- Vereinfachte push-up Oeffnung
- Ouverture par poussée simplifiée
- Apertura por empuje simplificada
- Eenvoudig push-up systeem voor openen en sluiten



- Sezione stecche
- Rib section
- Strebenprofil
- Section baleines
- Sección varillas
- Profiel baleinen



- Camino antivento
- Wind cap
- Windfang
- Souffle
- Chimenea antiviento
- Windvang



- Stecca con sistema "easy change"
- Ribs with "easy change" system
- Streben mit "easy change" System
- Baleines avec "easy change" système
- Varillas con sistema de " cambio fácil"
- Baleinen met het "easy change" systeem



- Blocco antivento
- Wind stop
- Windstop
- Block antivent
- Freno para el viento
- Windstop



- Con meccanismo manovella
- With winding mechanism
- Mit Kurbelmechanismus
- Avec mécanisme manivelle
- Con manivela
- Met opwindmechanisme

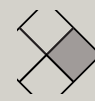

- Piastre cemento
- Cement slabs
- Kiesbetonplatten
- Dalles ciment
- Planchas de cemento
- Betontegel



- Fodero
- Cover bag
- Schutzhuelle
- Housse
- Forro
- Afdekhoes



- Doppia carrucola
- Double pulley
- Doppelter Seilzug
- Double poulie
- Doble polea
- Dubbele katrollen



- Sistema telescopico
- Telescopic system
- Teleskopsystem
- Système telescopique
- Sistema telescópico
- Telescoop systeem



- Sistema retrattile
- Retractable system
- Einziehbares System
- Système retractile
- Sistema retráctil
- Inklapbaar systeem



- Ombrellone girevole a 360°C
- 360-degree rotating umbrella
- 360° drehbarer Schirm
- Parasol rotatif à 360°
- Parasol giratorio de 360°
- 360° draaibare parasol



- Inclinazione fino a 20°
- Inclination up to 20°
- Neigung bis zu 20°
- Inclination jusqu'à 20°
- Inclinación hasta 20°



- Inclinazione fino a 60°
- Inclination up to 60°
- Neigung bis zu 60°
- Inclination jusqu'à 60°
- Inclinación hasta 60°

INOX

- Viteria in inox
- Screws in Stainless steel
- Edelstahlschrauben
- Visserie inox
- Tornillos en acero inoxidable
- Schroeven van rvs



- Tipo finitura della struttura/sostegno/componenti
- Finishing for frame/structure/components
- Ausfuehrung des Gestells/der StrENtur/der Bestandteile
- Finition armature/structure/composants
- Tipo de acabado de la estructura/Soportes/ componente



DYSTRYBTOR PARASOLI OGRODOWYCH SCOLARO

www.scolaro-parasole.pl
e-mail: kontakt@scolaro-parasole.pl
tel. +48 605 194 418

SCOLARO-PARASOL.IT